

FRONT

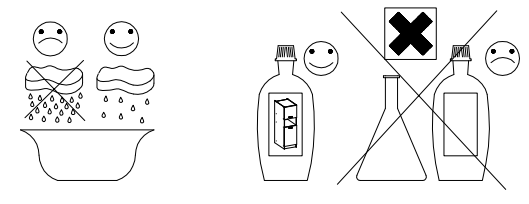

60 DK-2100 2F

60 LO-2100

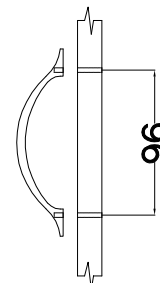
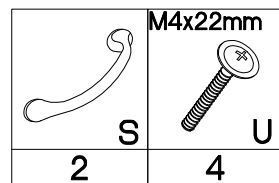
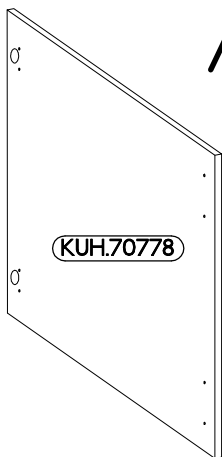
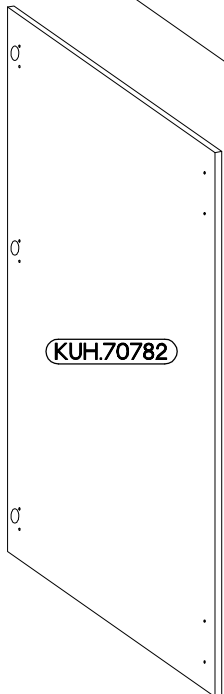
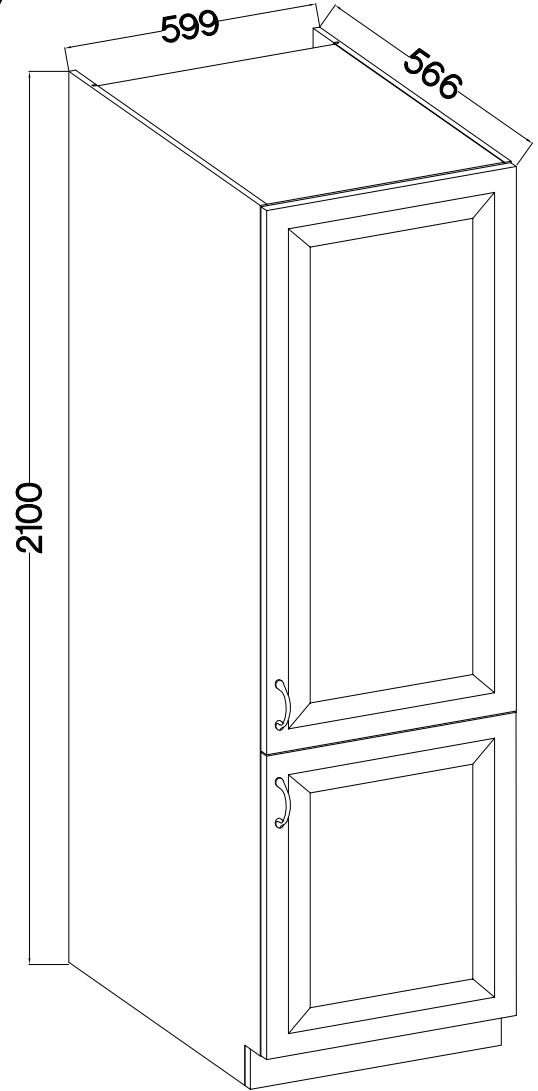
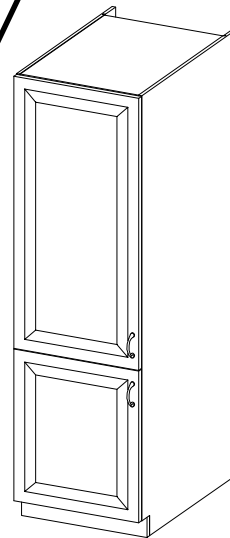
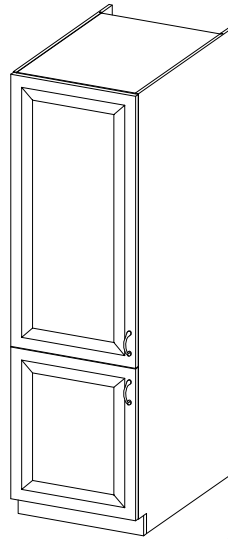
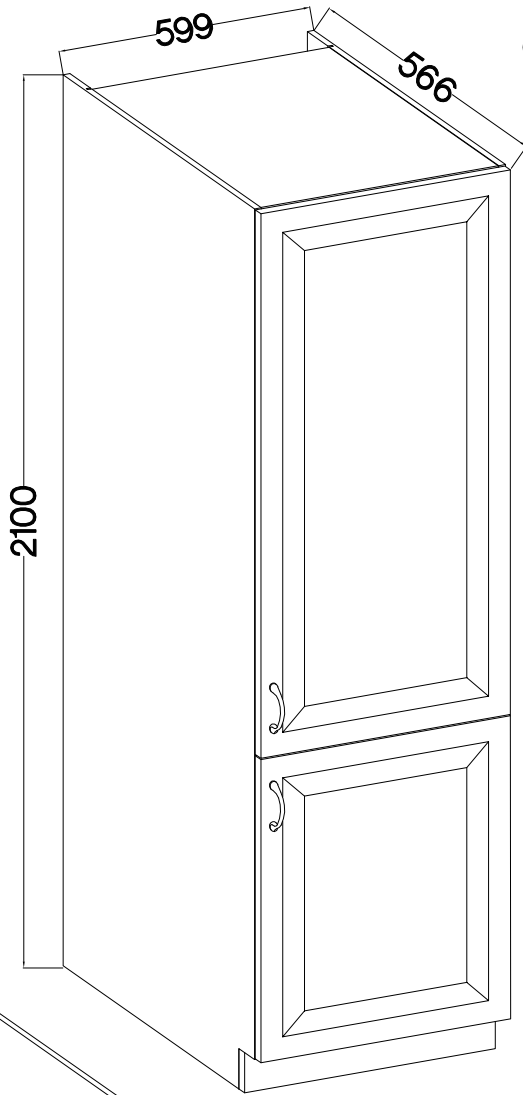

ISM-KUH-01205

1 60 DK-2100 2F

LEFT

RIGHT

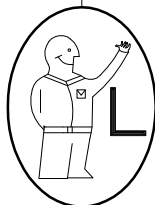
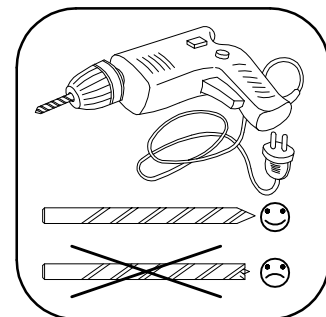

KUH.70782



KUH.70782

KUH.70778

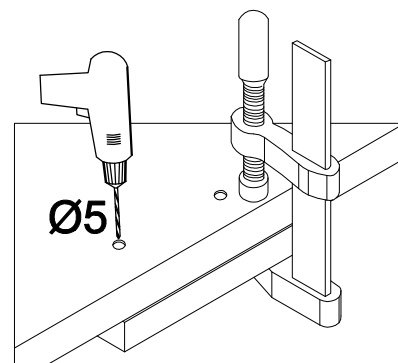
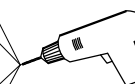
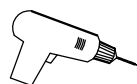
KUH.70778



2

 †35/0mm HG 5	 †3.5x13mm P5 10
---	--

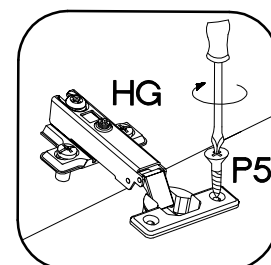
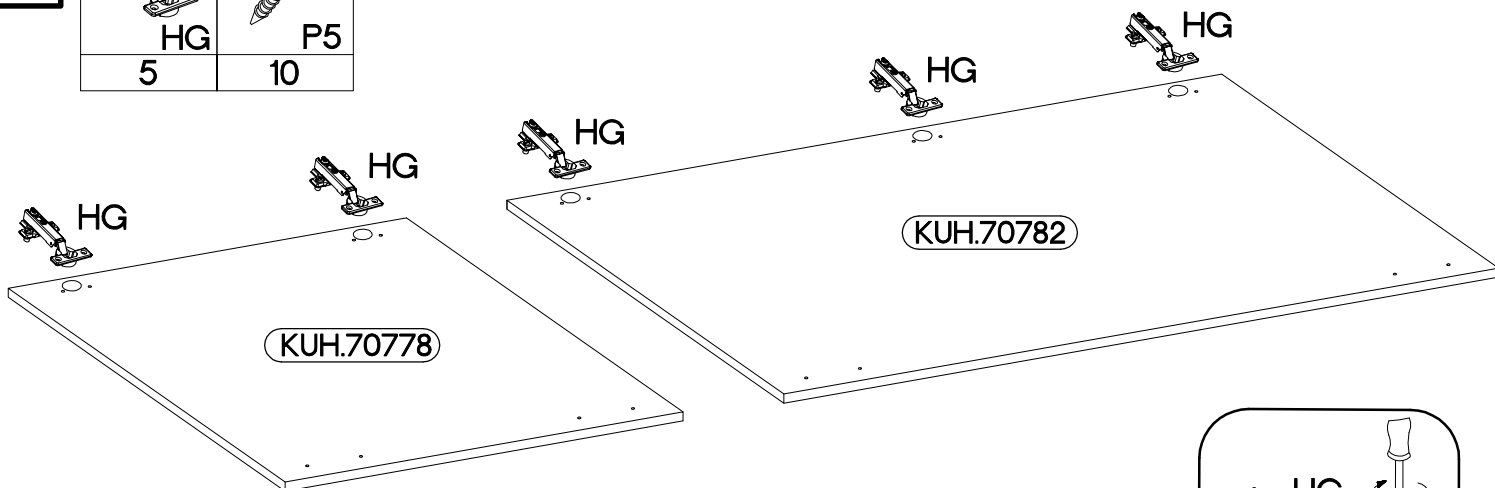

3

M4x22mm



U

4



S

2

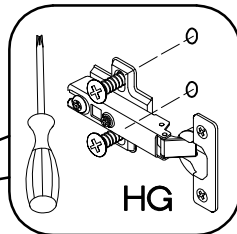

HG



R

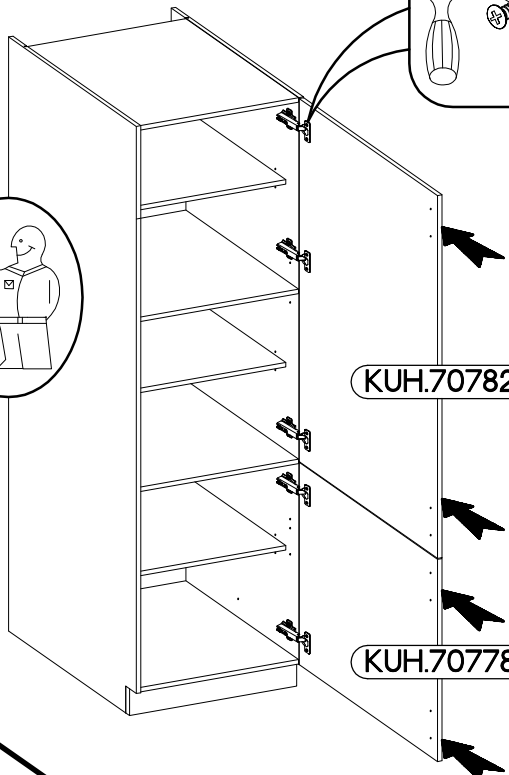

KUH.70782

KUH.70778

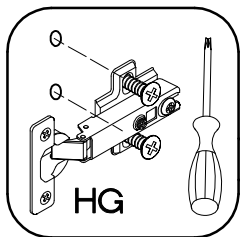

HG

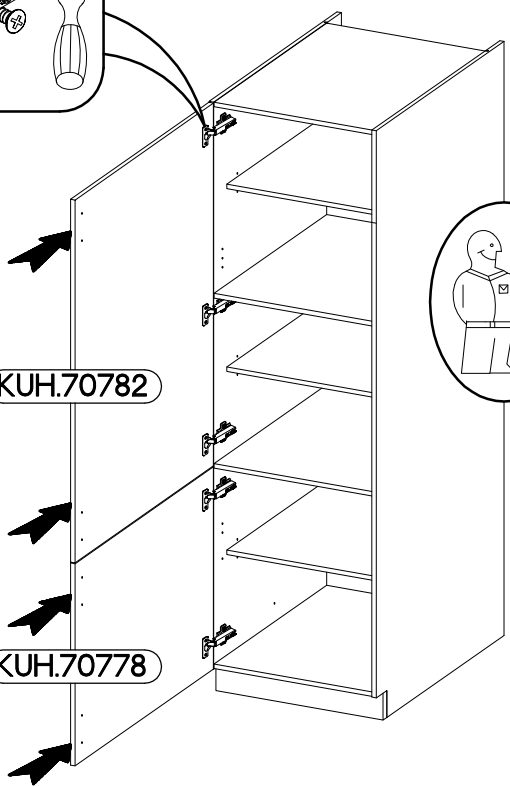

KUH.70782

KUH.70778

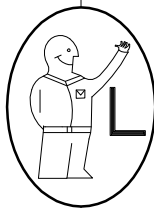

L

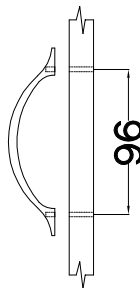

96

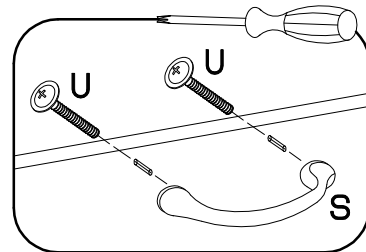

U

S

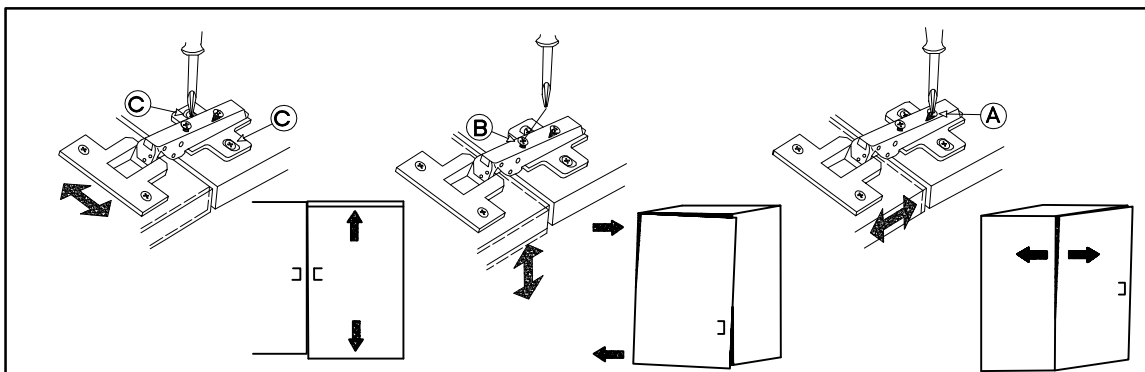

LEFT

RIGHT

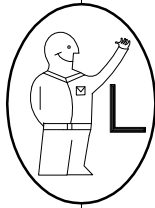
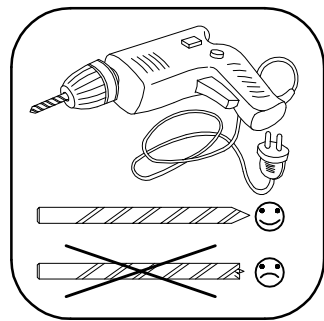

KUH.70782

KUH.70782

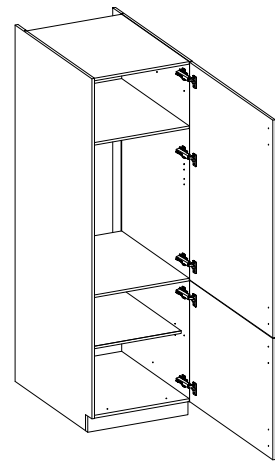
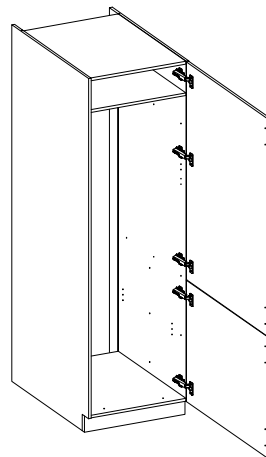
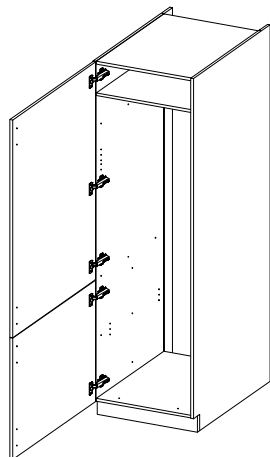
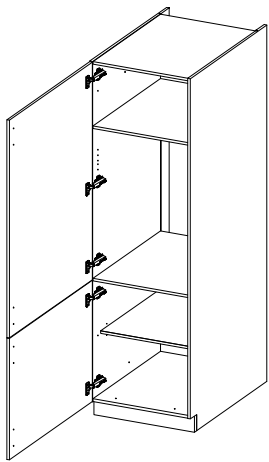
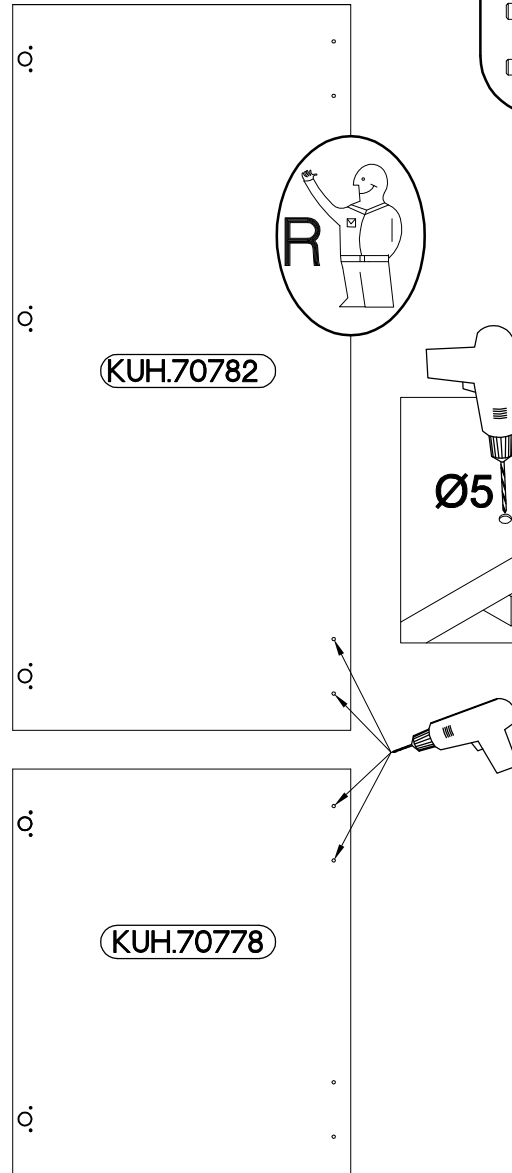
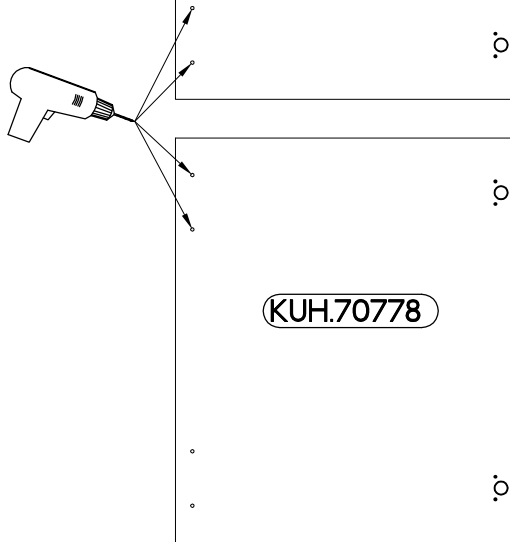
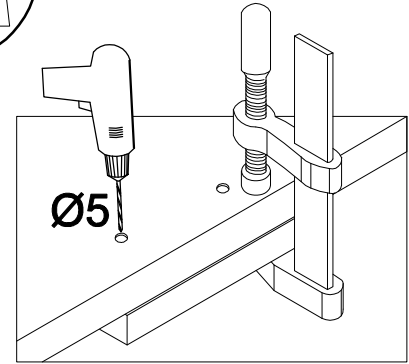

5

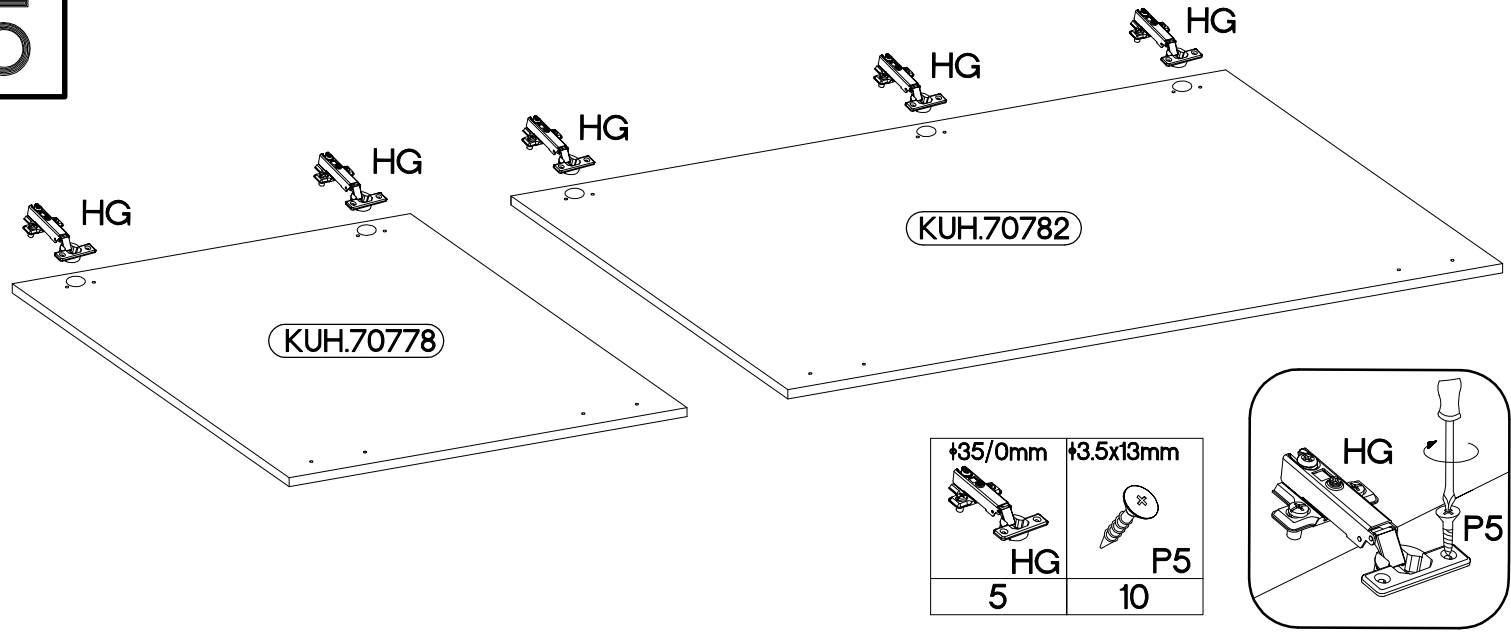

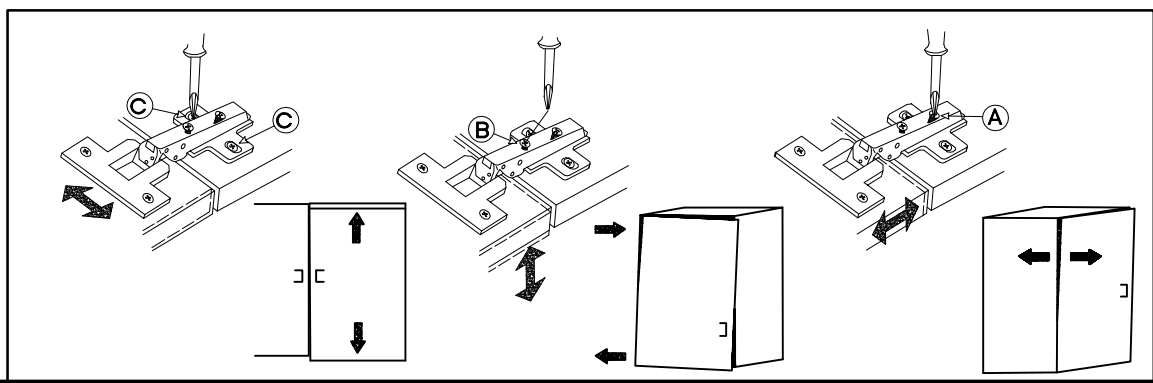
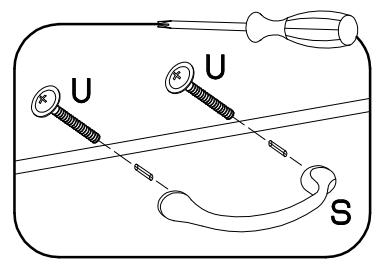
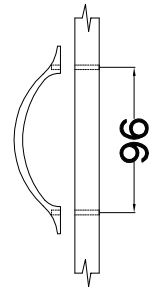
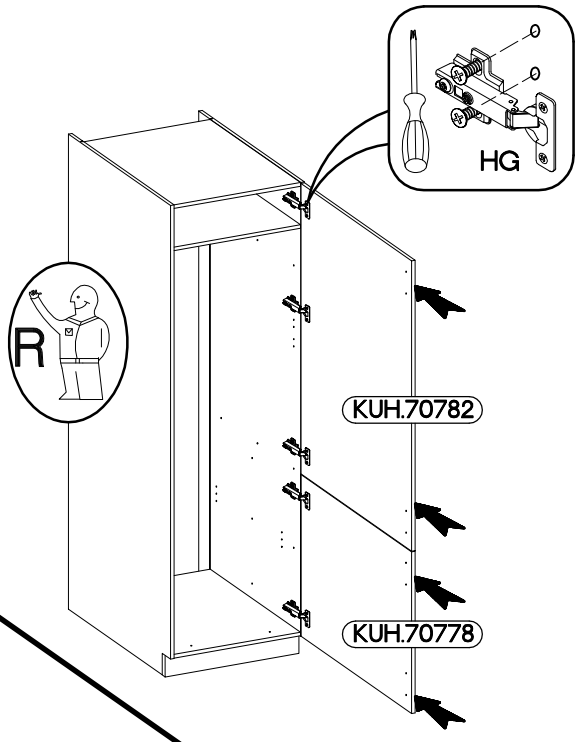
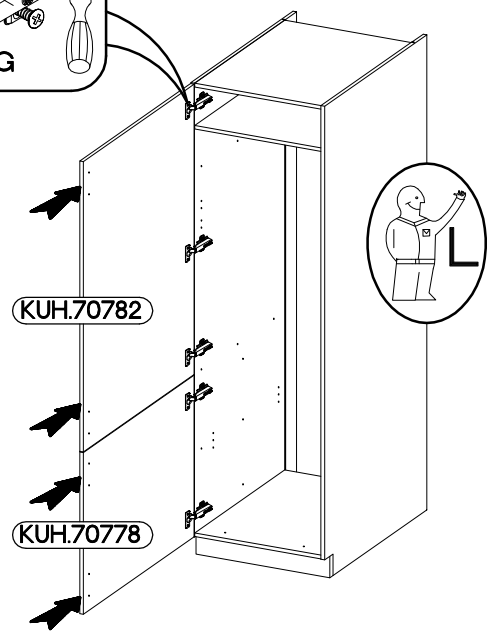
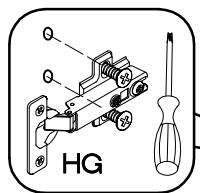

6 WARIANT A

M4x22mm U 4	S 2
-------------------	--------



7 | WARIANT B

M4x22mm	
	
U	S
4	2

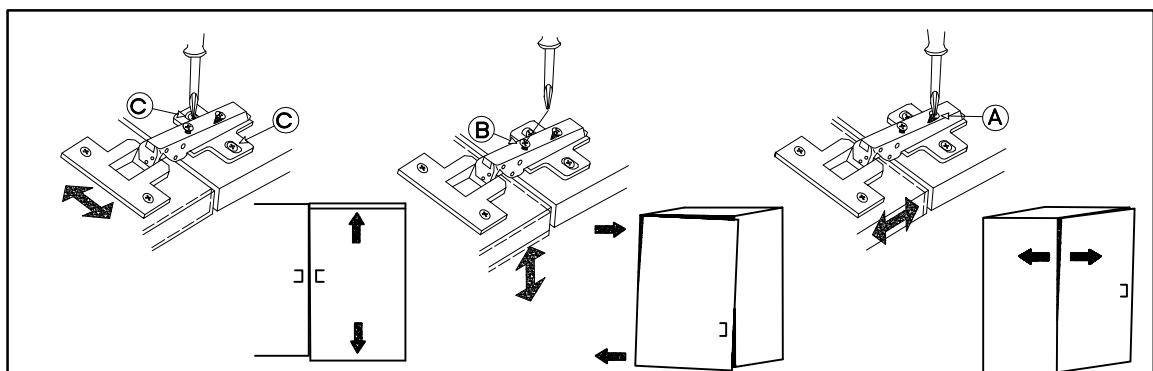
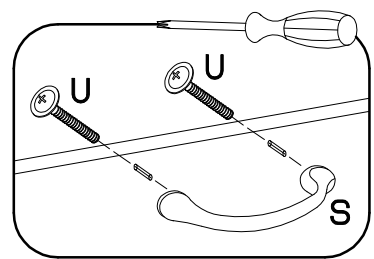
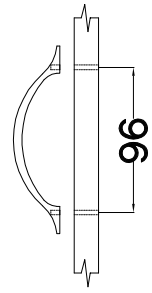
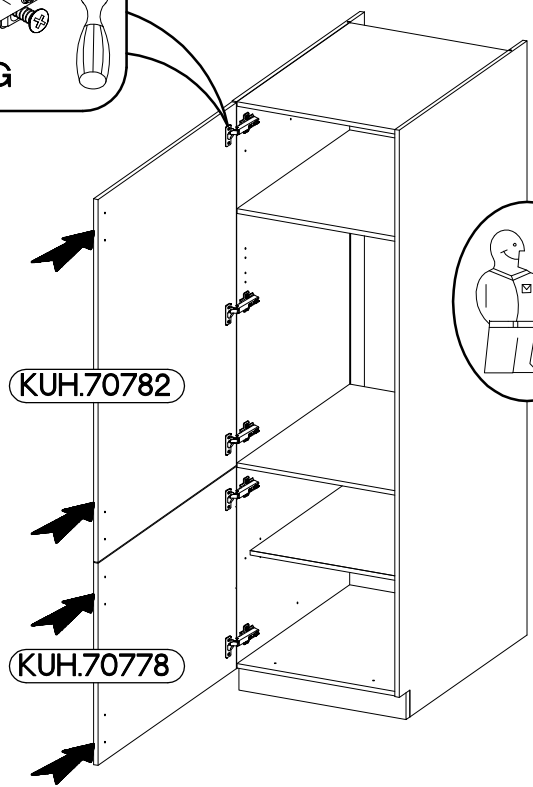
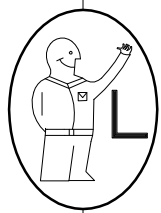
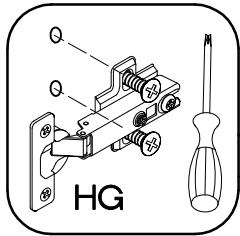
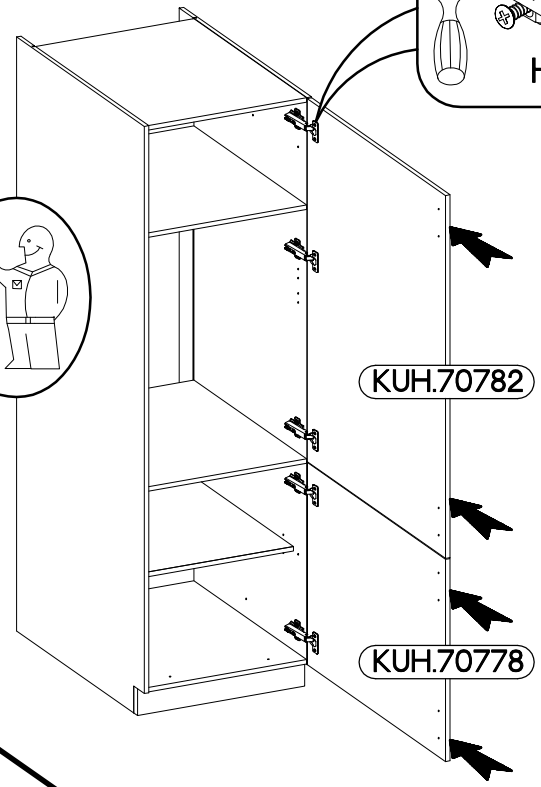
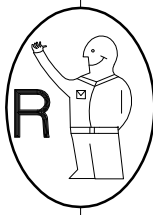
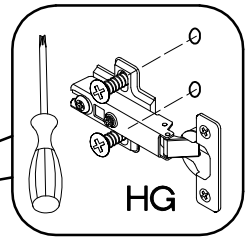

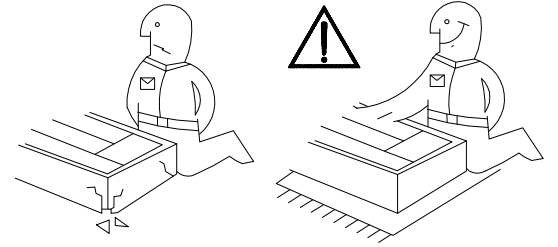
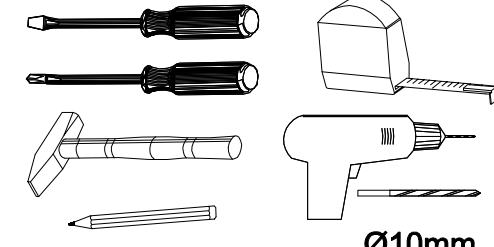
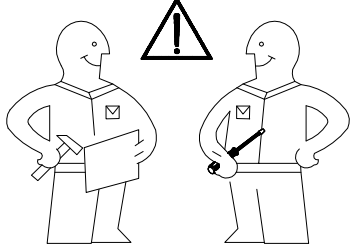

Ø10mm

60 LO-2100

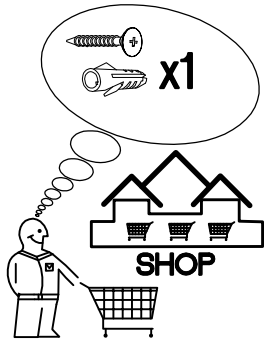
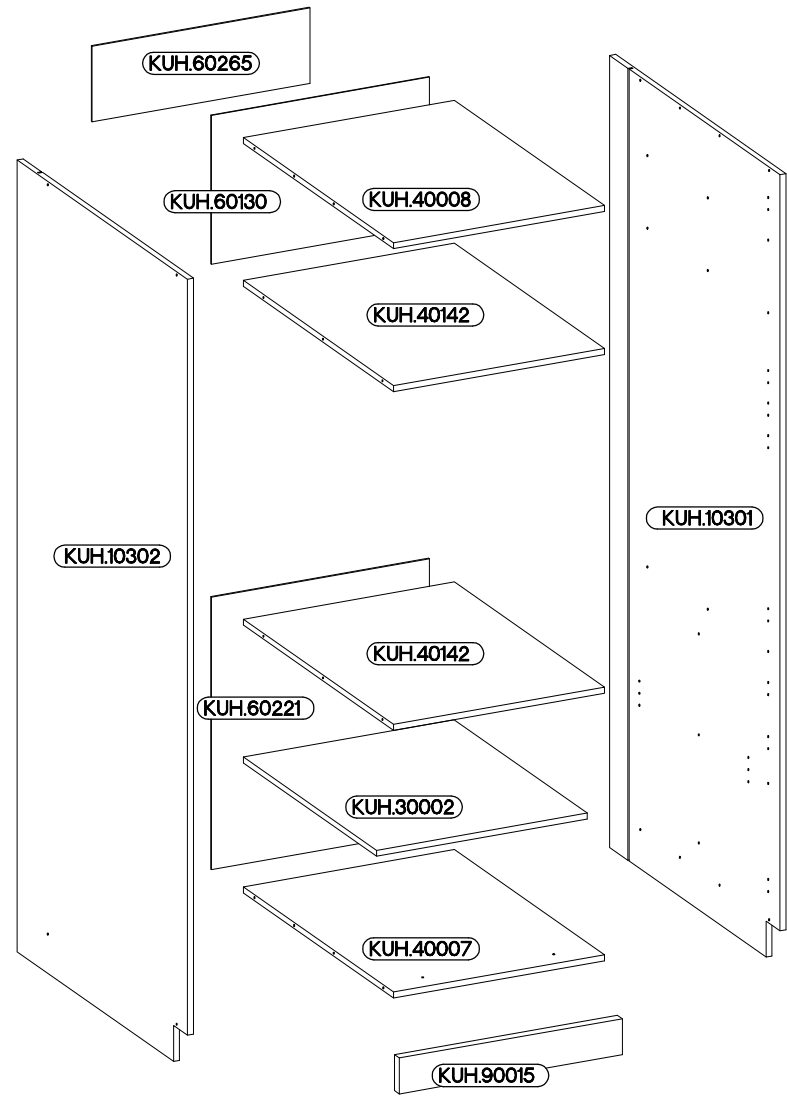
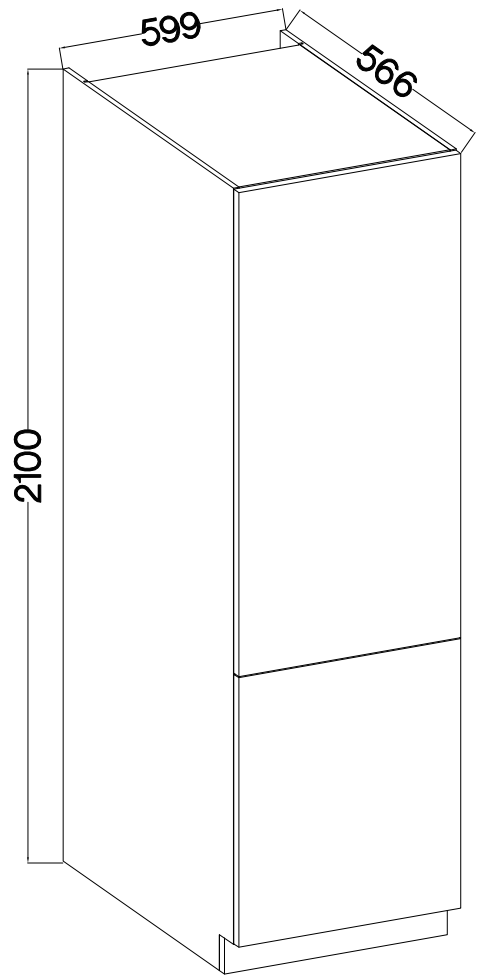
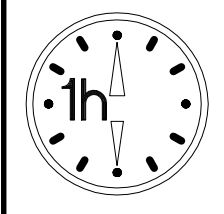
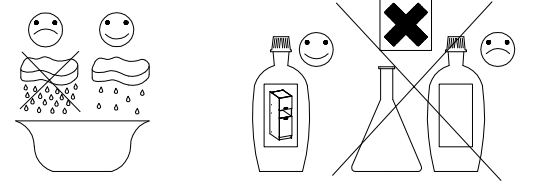

$\dagger 8 \times 30 \text{mm}$	$6,4 \times 50 \text{mm}$	$\dagger 15/12 \text{mm}$
A	B	C
8	8	12

L=20mm				6.5x48x16	$\dagger 35/0 \text{mm}$	$\dagger 5/19 \text{mm}$
D2	E	E1	E9	F2	HG	J
12	12	8	2	4	5	4
		$\dagger 4.0 \times 16 \text{mm}$	$\dagger 4.0 \times 45 \text{mm}$	$\dagger 3.5 \times 13 \text{mm}$	$\dagger 3.0 \times 20 \text{mm}$	
L25	O	P1	P4	P5	P7	T4
1	1	16	2	12	15-20	4

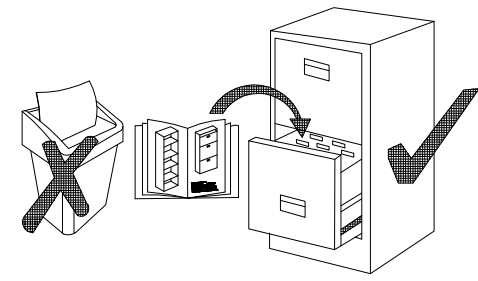

ISM-KUH-01148

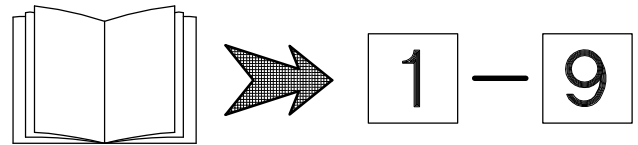
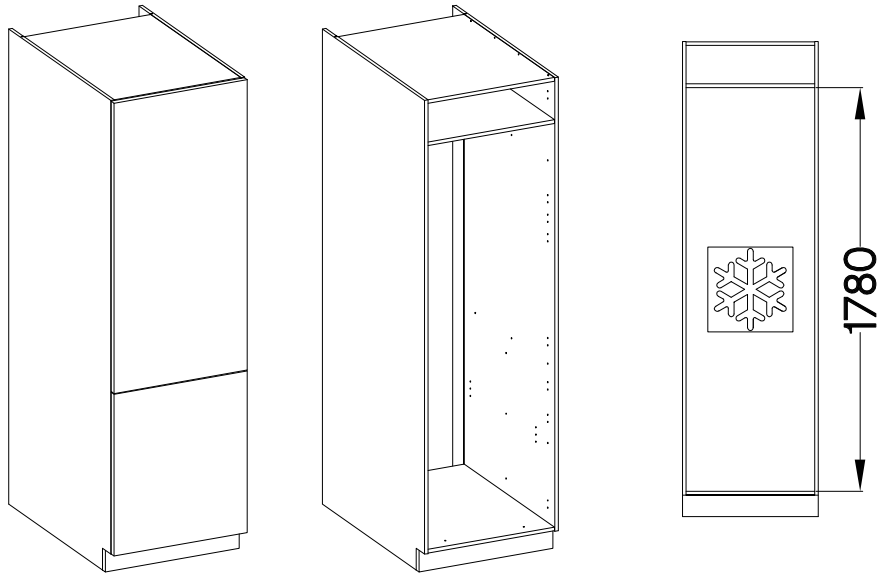



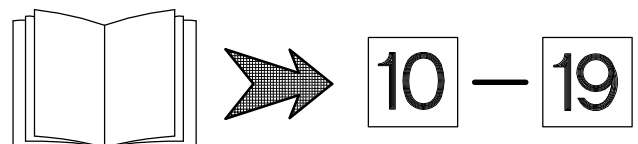
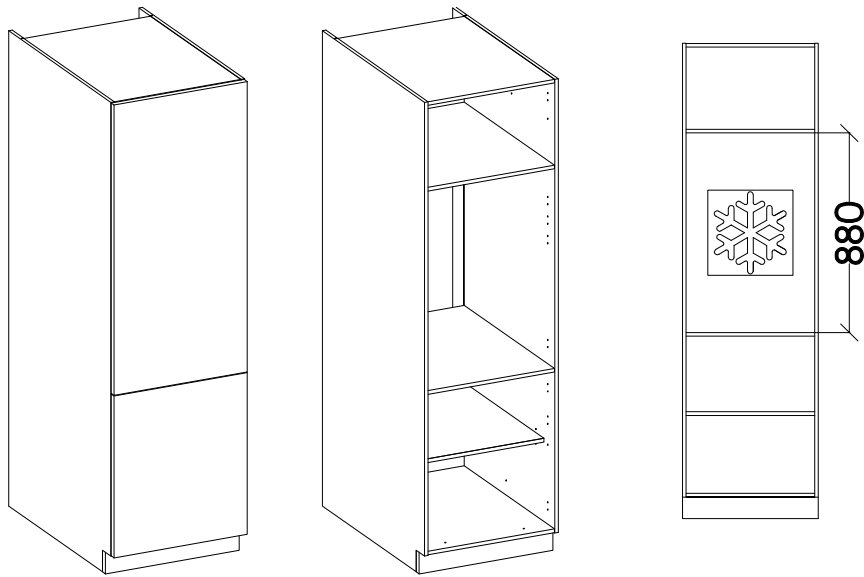

WARIANT B

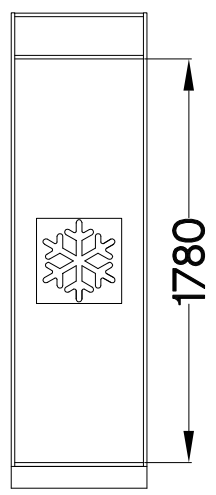
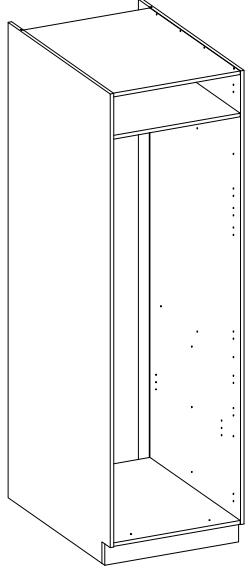

1

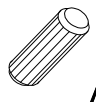
WARIANT A



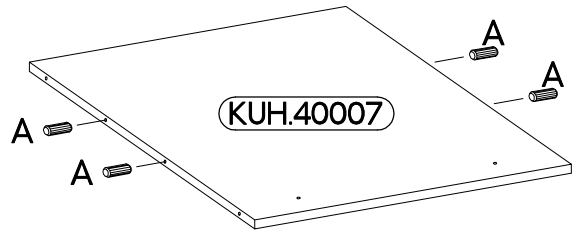
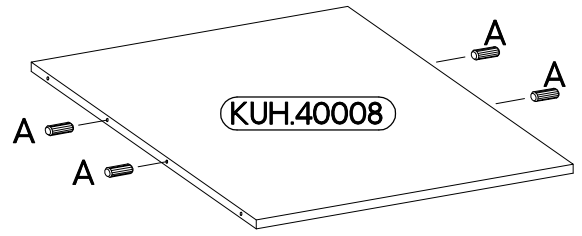
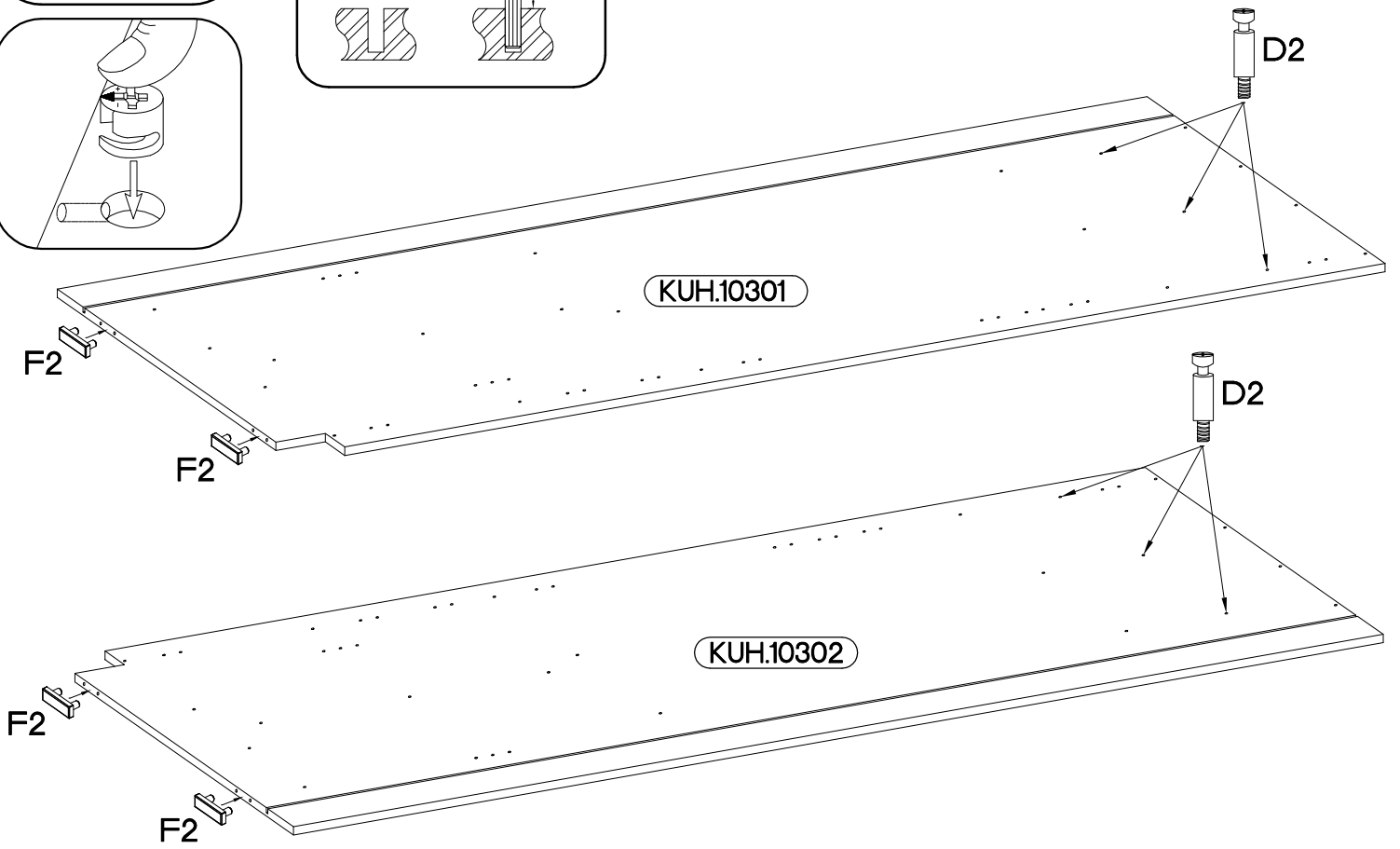
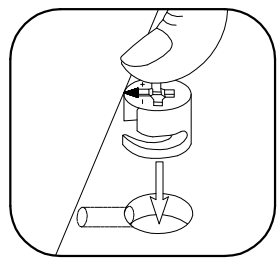
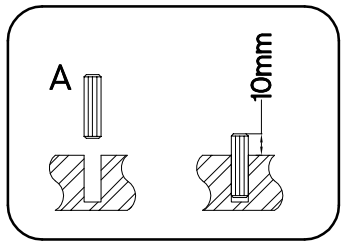
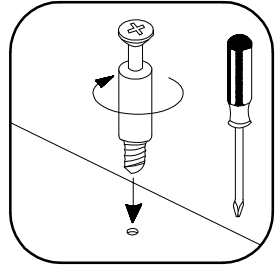
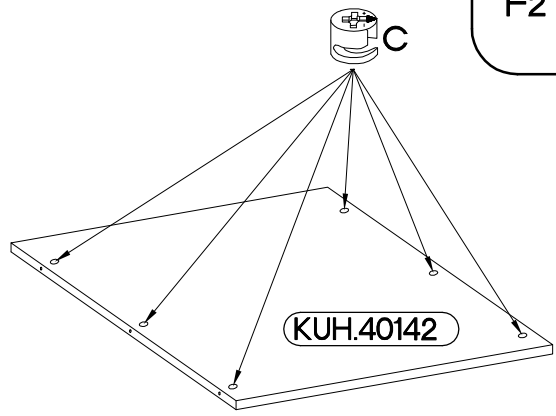
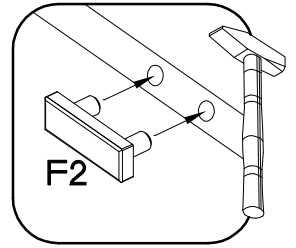
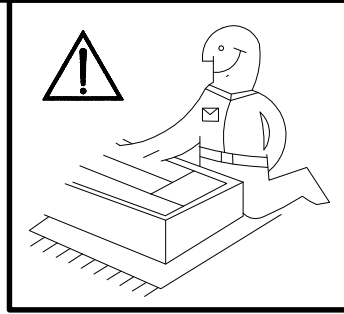

$\varnothing 8 \times 30 \text{mm}$  A	$6.5 \times 48 \times 16$  F2
8 L=20mm  D2	4 $\varnothing 15 / 12 \text{mm}$  C
6	6

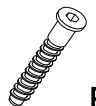
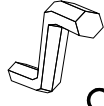

2

6,4 x 50mm

		
B	O	E1
4	1	4

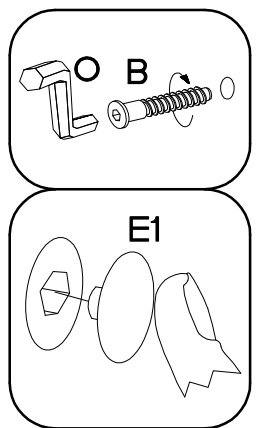
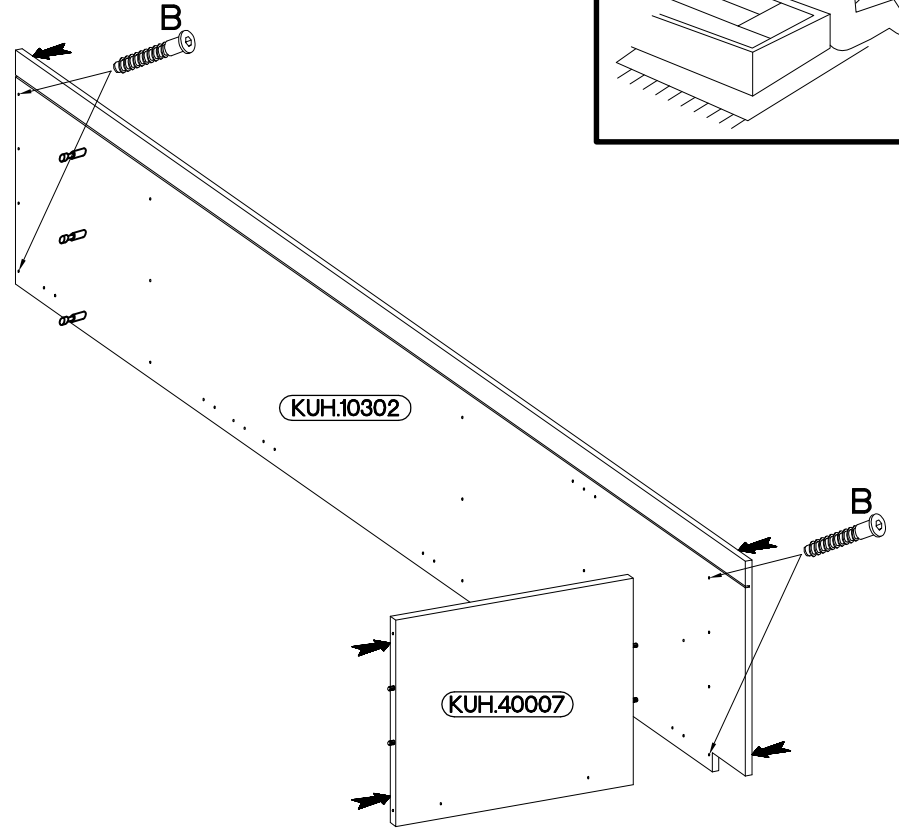
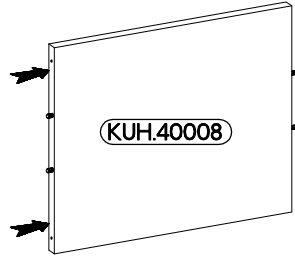
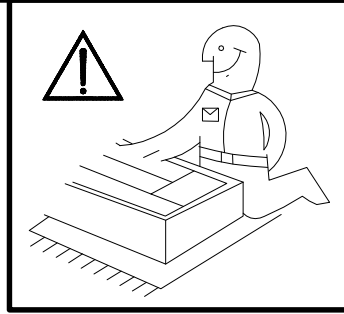



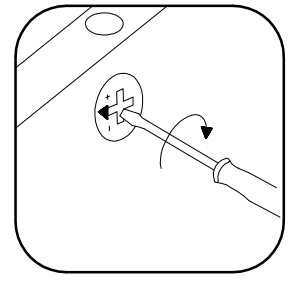
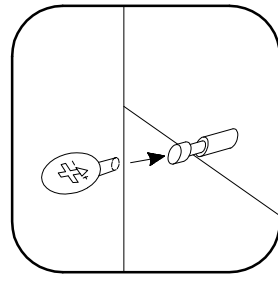
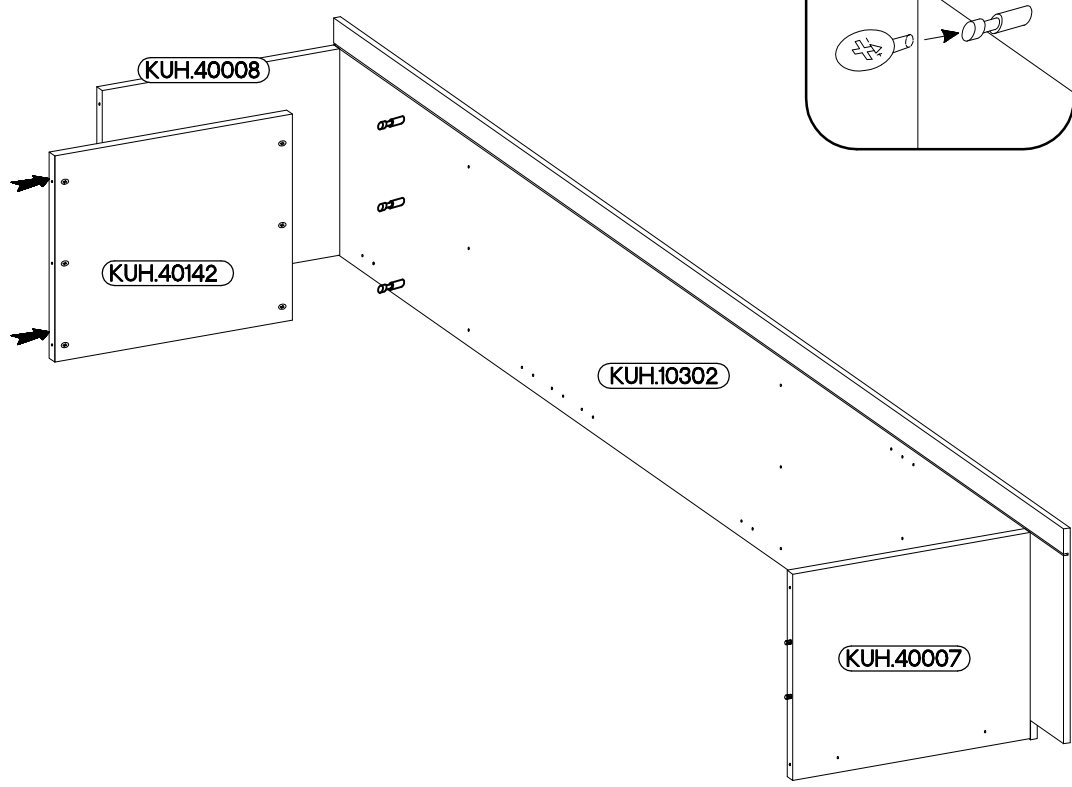

3





4

6,4 x 50mm

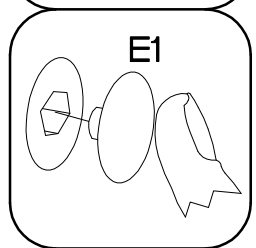
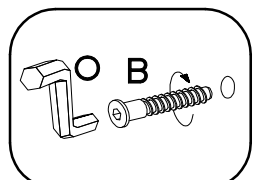
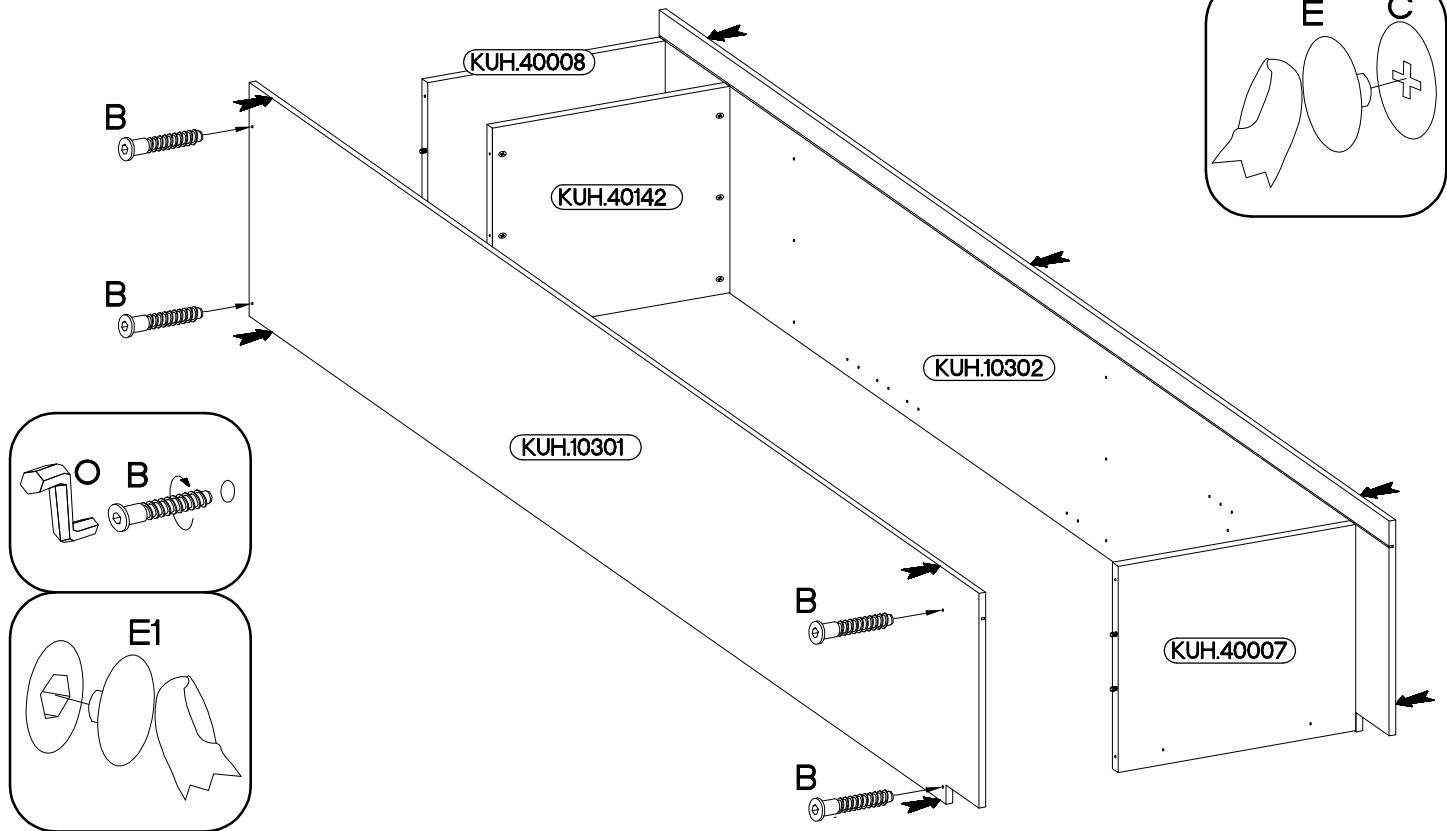
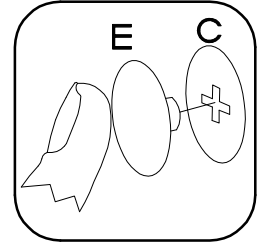
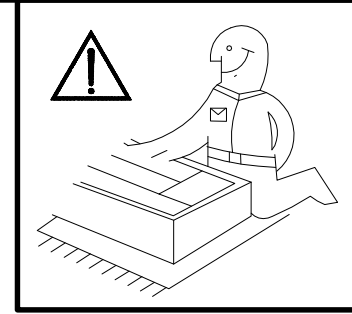
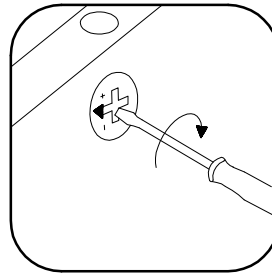
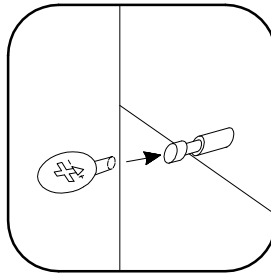
			
B	O	E1	E
4	1	4	6



5

	
T4	P1
4	16

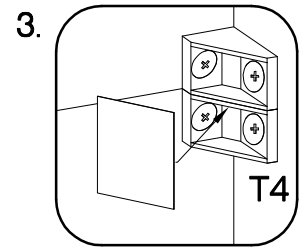
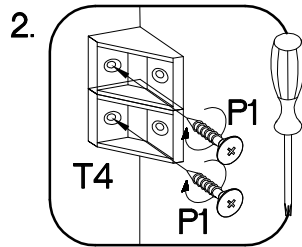
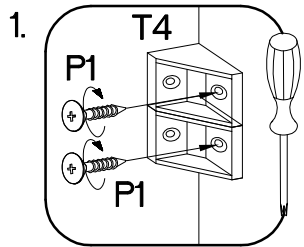
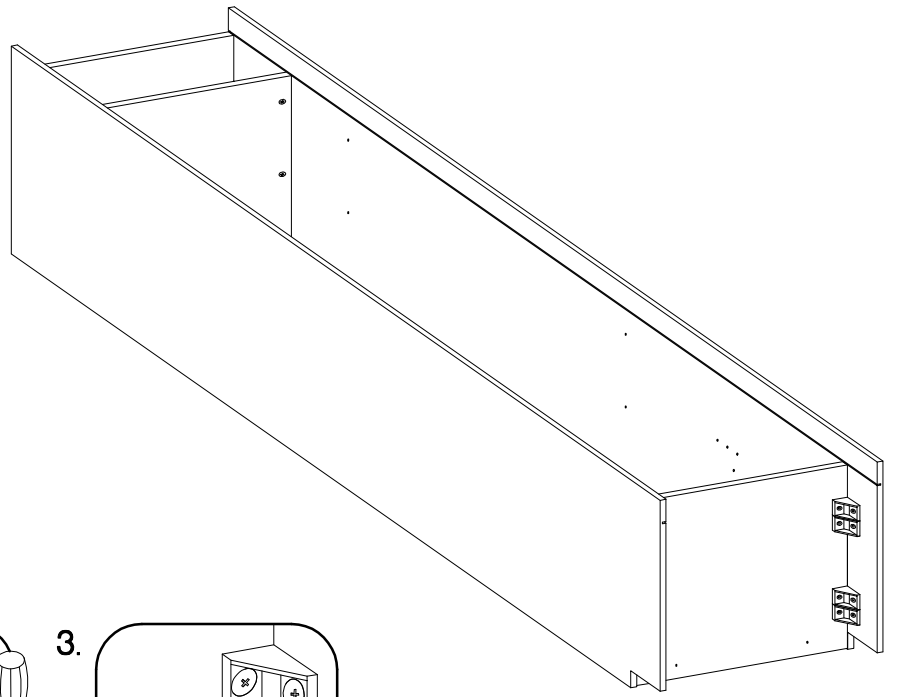
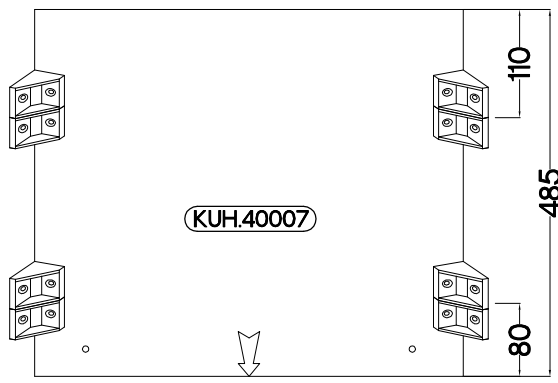

+4.0x16mm

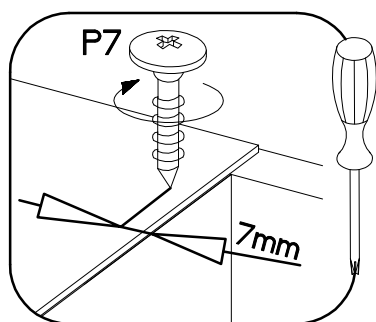
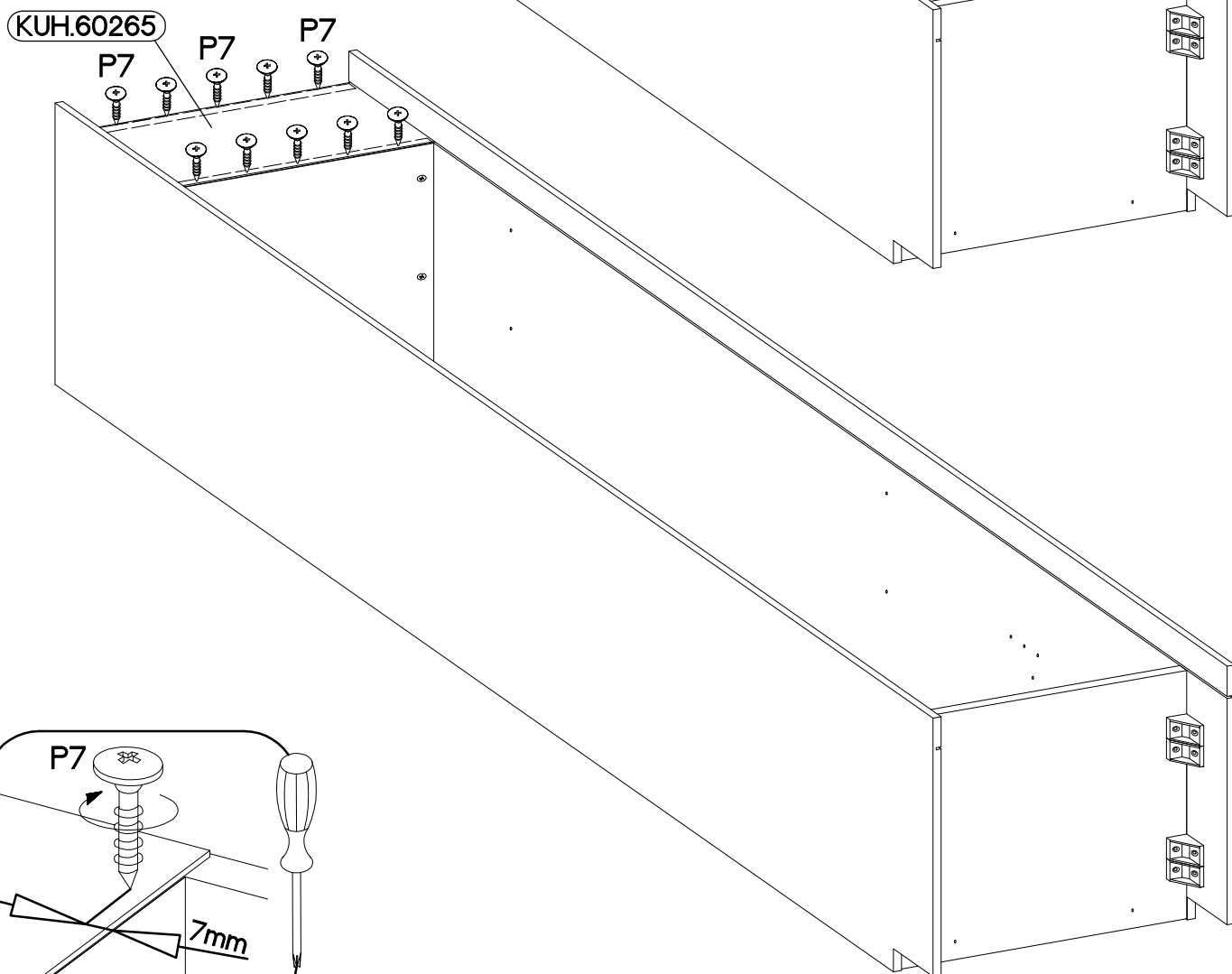
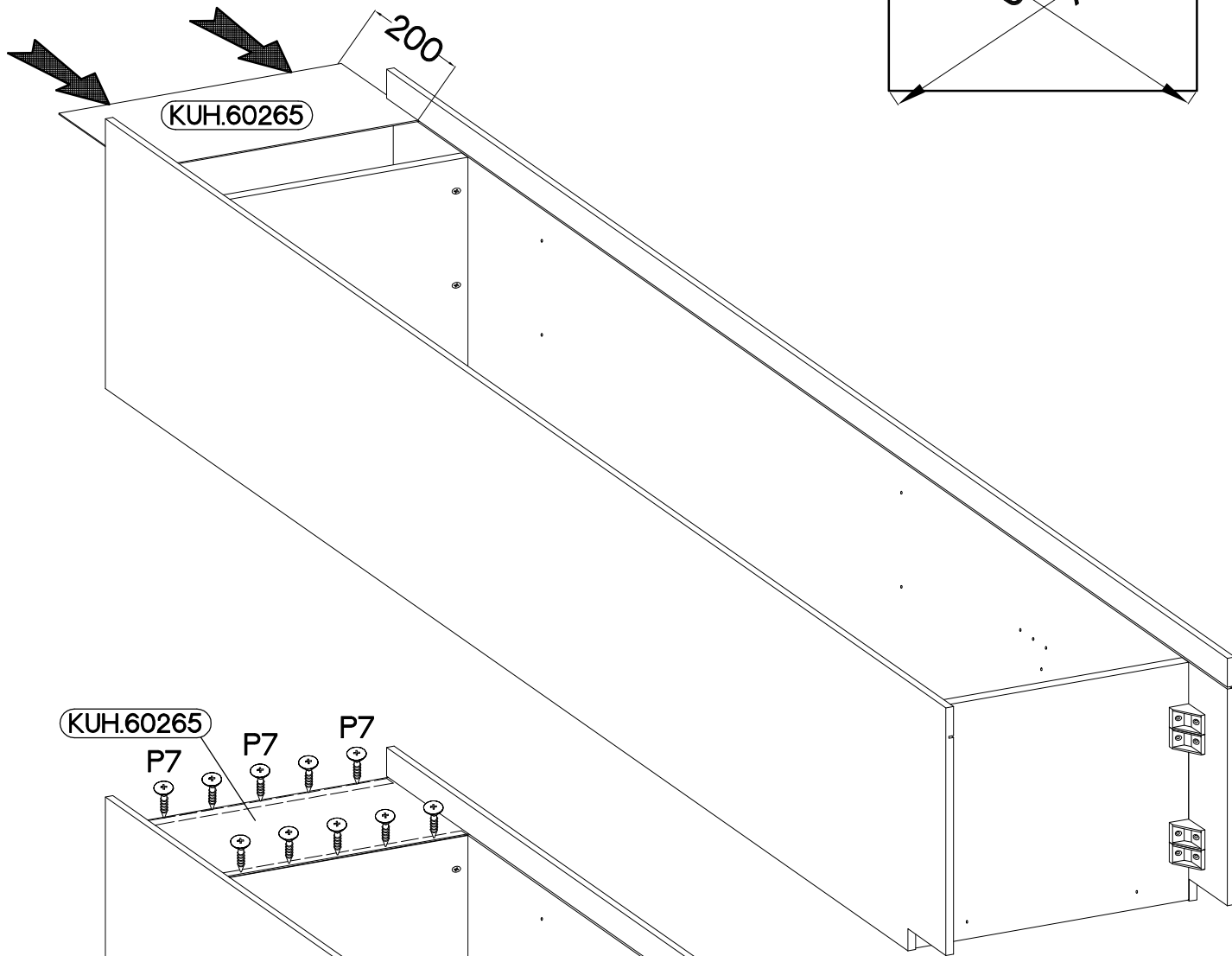
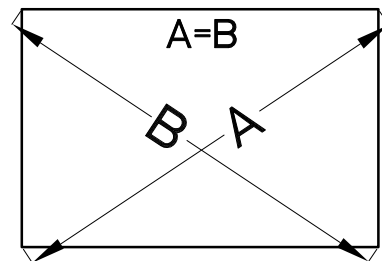

6

±3.0x20mm
P7
8-10

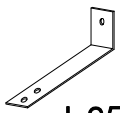

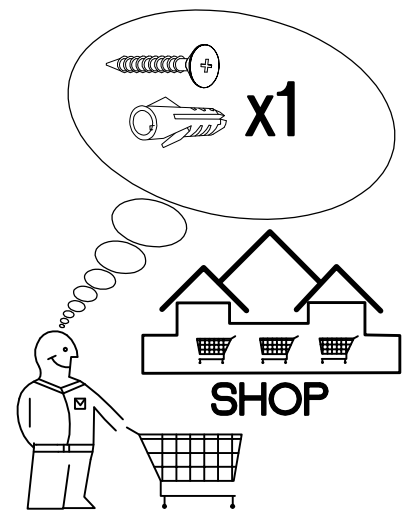
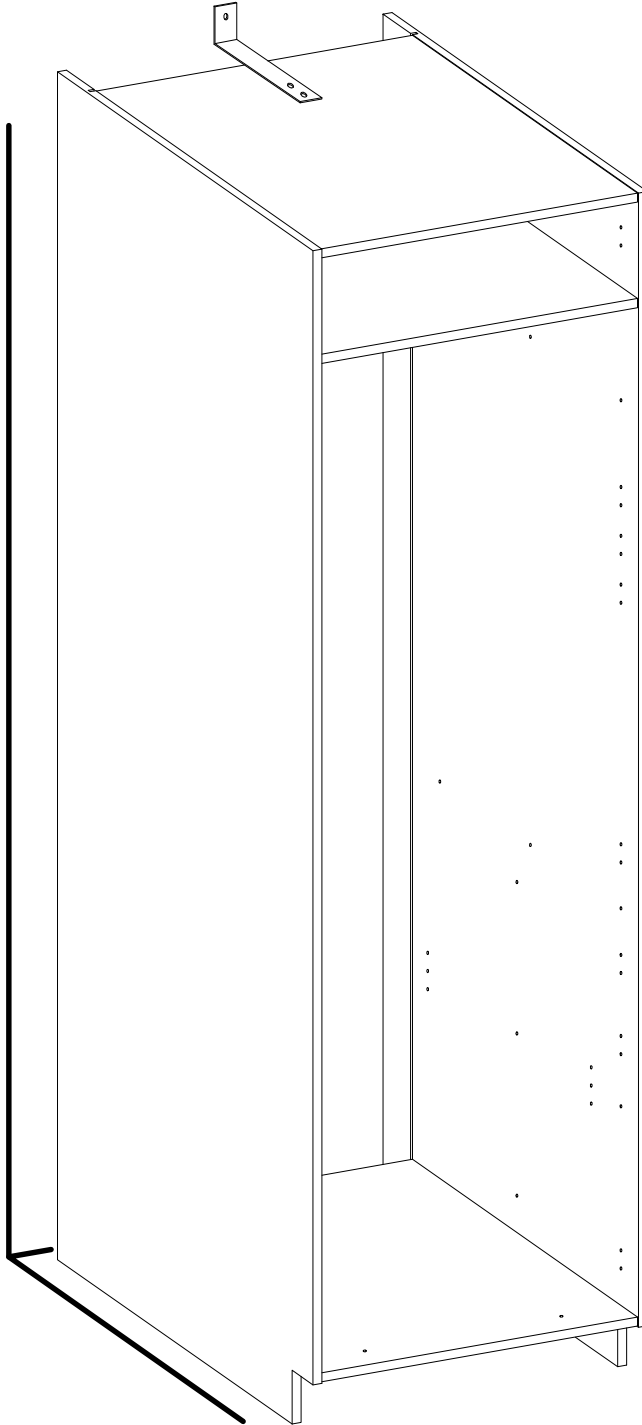
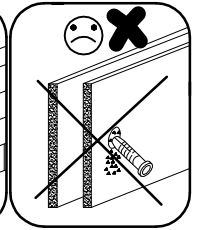
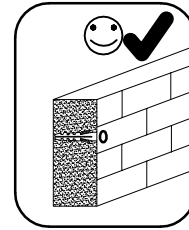
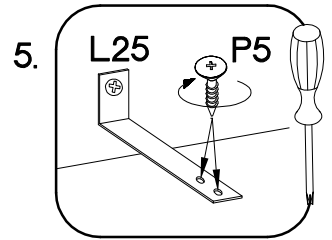
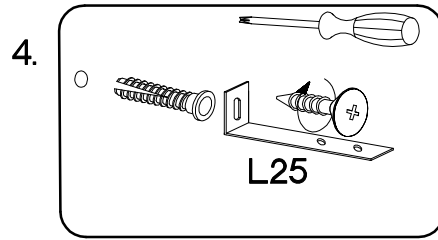
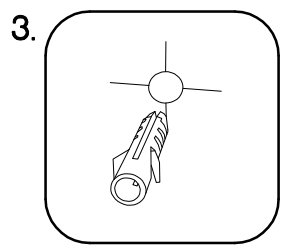
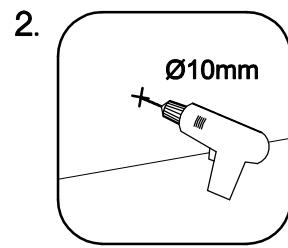
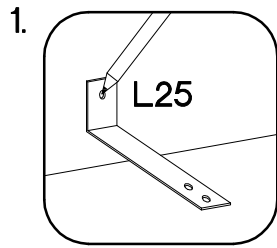

 L25 1	 P5 2
--	---

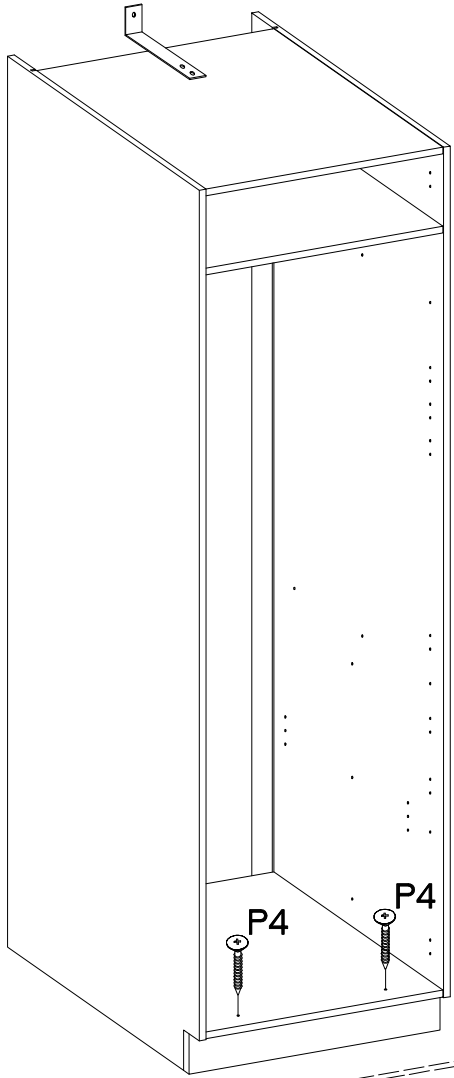

8



+4.0x45mm  P4 2	 E9 2
--	---

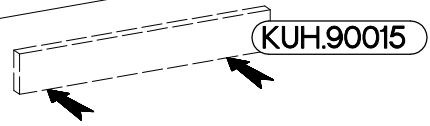
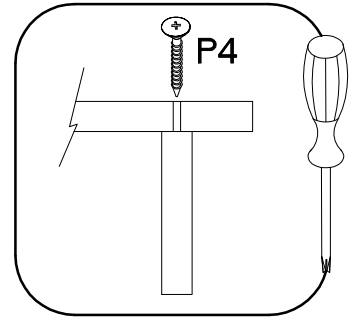

9

