

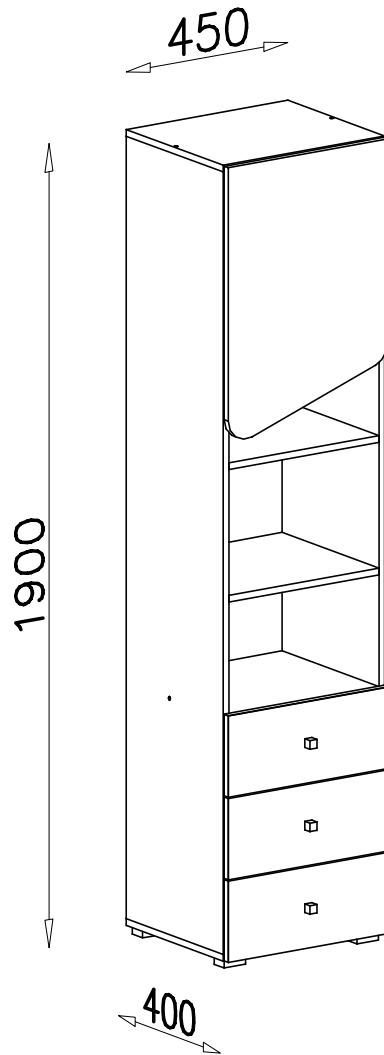

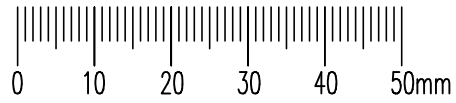

# DELTA DL6

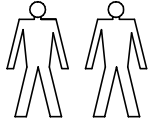
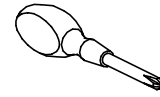
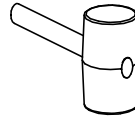
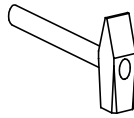
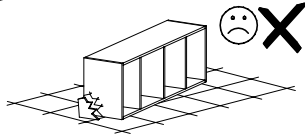
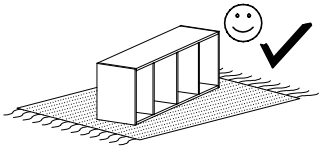
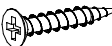

**G12**  
  
 3,5x25 x8

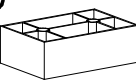
**E38**  
  
 x3

**P15**  
  
 x4

**A1**  
  
 ø7x50 x6

**W1**  
  
 GLUE, LEIM, LEPIDLO, LIM x2

**G4**  
  
 4x16 x22

**B7**  
  
 ø8x30 x36

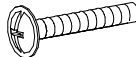
**N13**  
  
 M4x22 x3

**G2**  
  
 3x20 x45

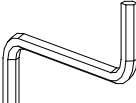
**W2**  
  
 x1

**D3**  
  
 PZ35PR x2

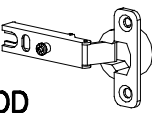
**C3**  
  
 Z350D x2

**F1**  
  
 x12

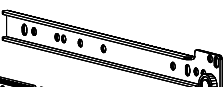
**H7**  
  
 350mm x3

**G10**  
  
 6x13 x12

1

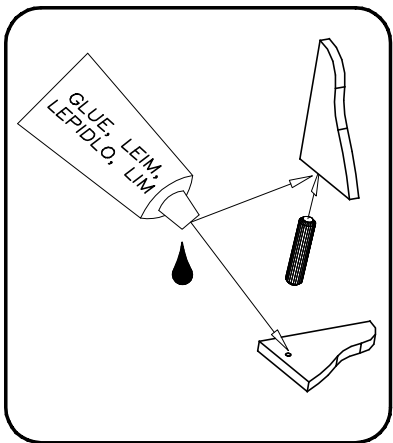
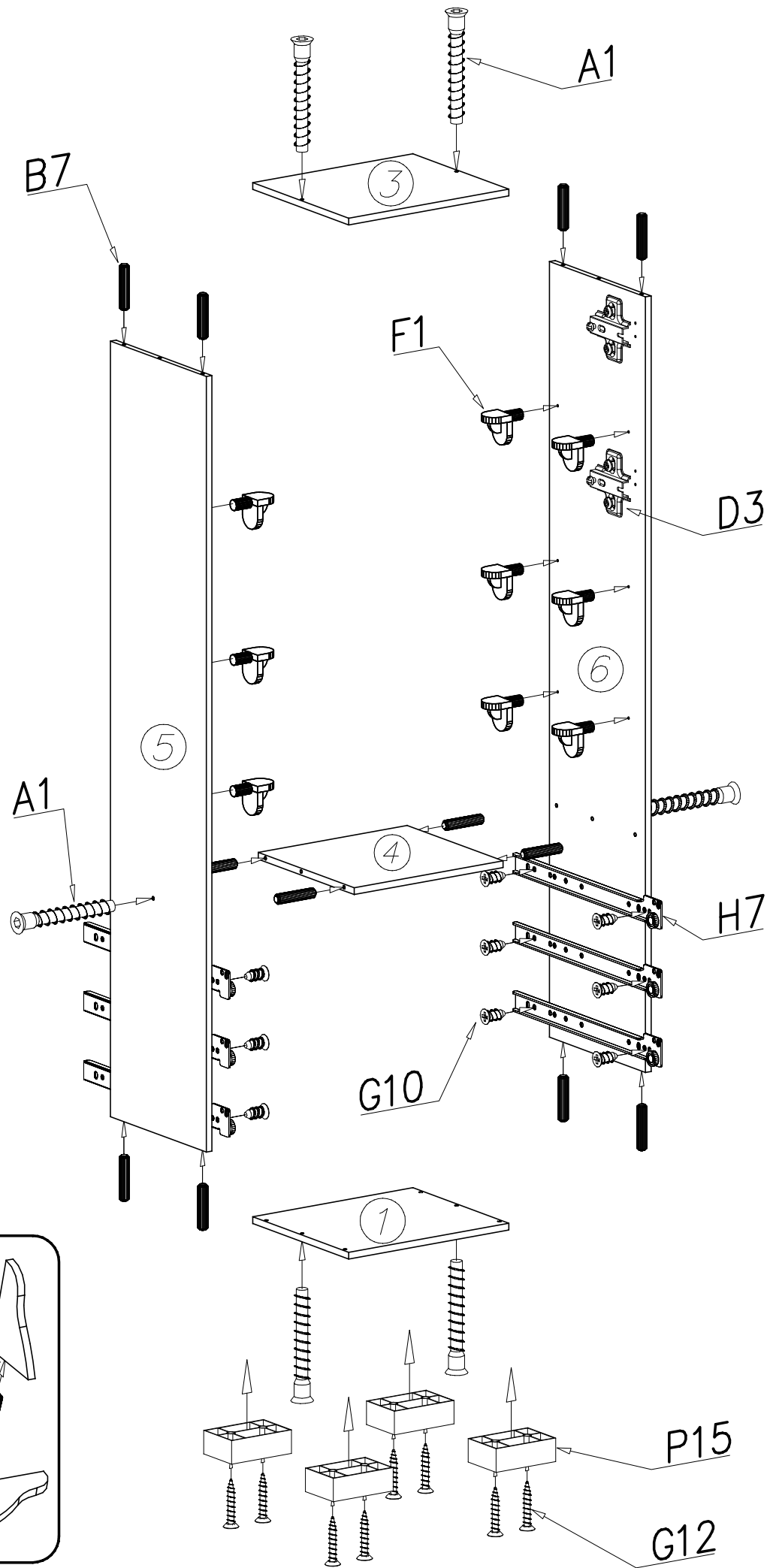

II

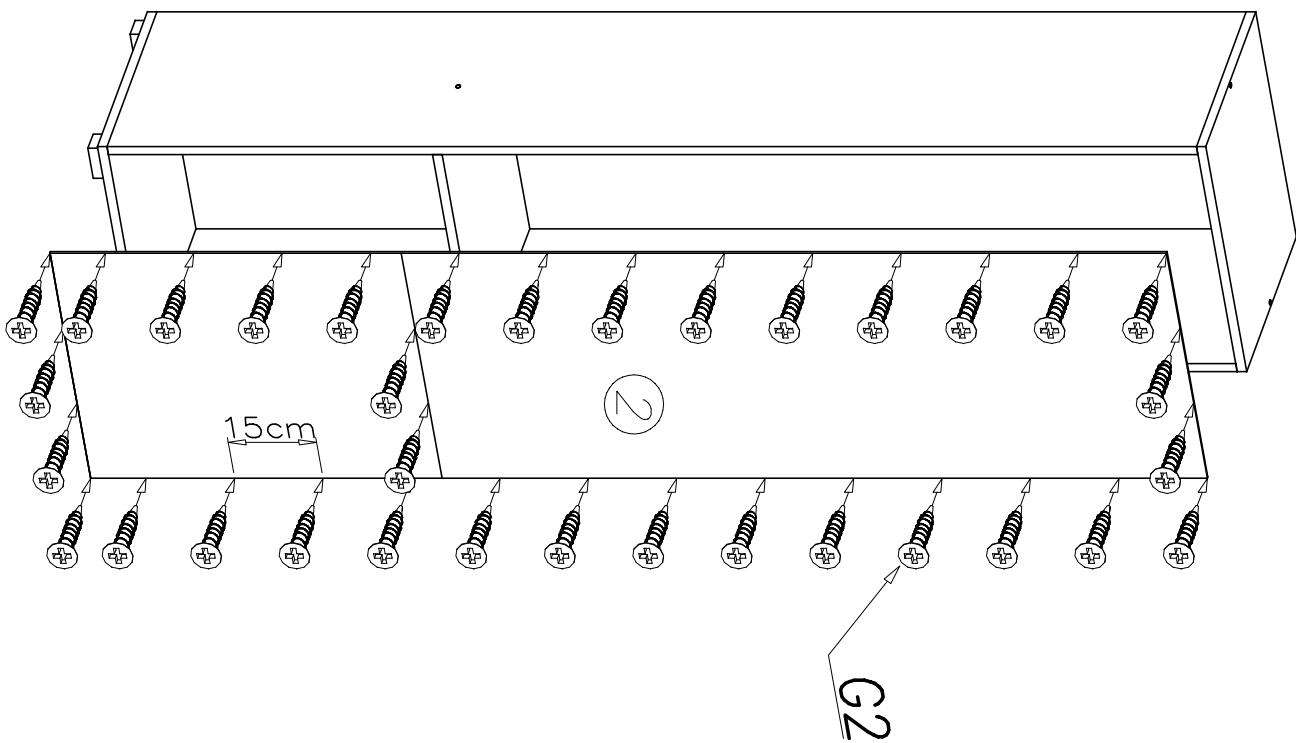

III

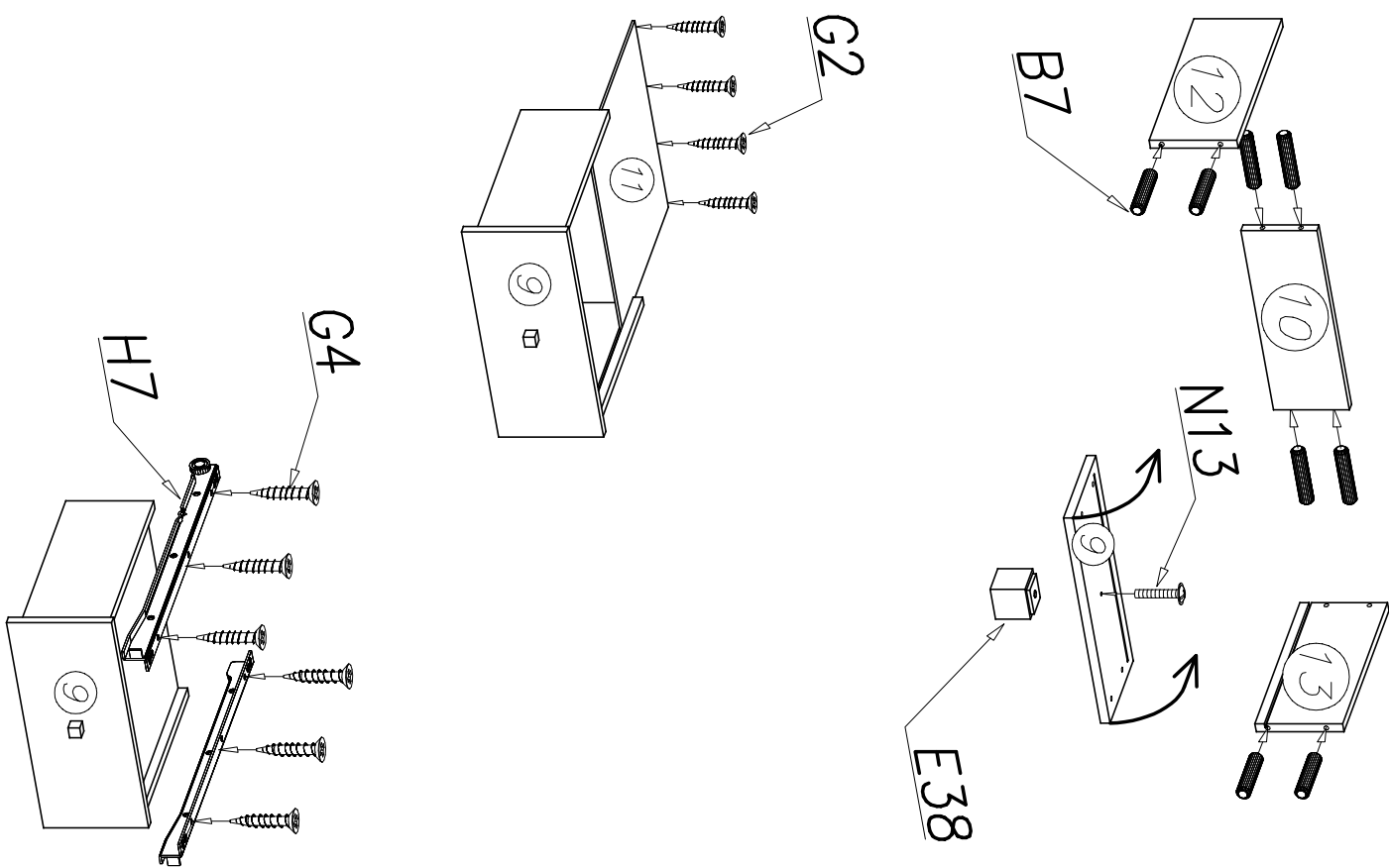

IV

