

# emmezeta.hr

NOTICE DE MONTAGE  
ASSEMBLING INSTRUCTIONS  
ISTRUZIONI DI MONTAGGIO  
MONTAGEANLEITUNG  
ISTRUCOES DE MONTAGEM  
MANUAL DE MONTAJE  
UPUTE O MONTAŽ

## SEVILLA PET SEVS21

PRODUCT CODE: 624312

Version: 01- 08.2018

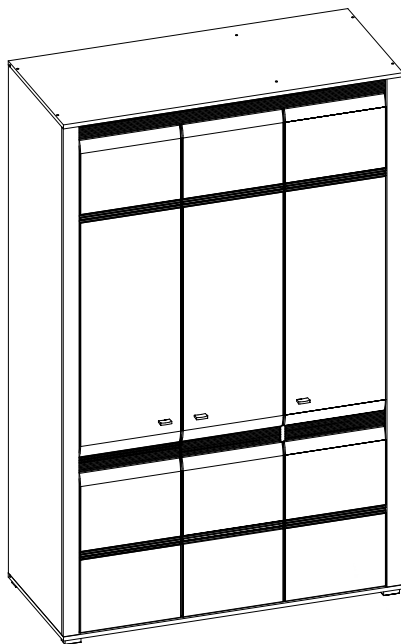
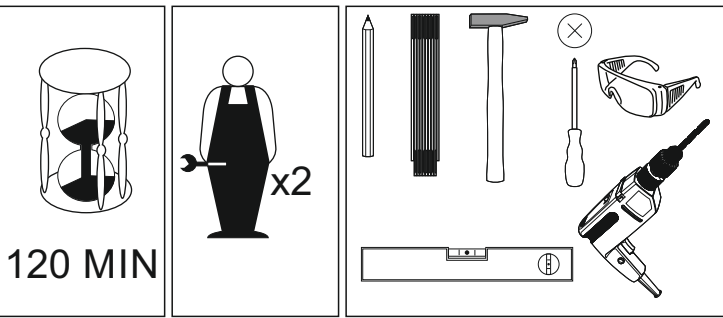

AVANT DE COMMENCER, SE  
REPORTER AUX CONSEILS  
DE MONTAGE EN ANNEXE

BEFORE STARTING, REFER  
TO THE ASSEMBLING ADVICE  
IN ANNEX

VOR DER MONTAGE,  
BEILIEGENDE ANWEISUNGEN  
BEFOLGEN.

PRIMA DI COMINCIARE LEGGETE  
LE ISTRUZIONI DI MONTAGGIO

ANTES DE COMERCAR, ADIAR  
SE AOS CONSELHOS DE  
MONTAGEM EM ANEXO

ANTES DE EMPEZAR  
CONSULTE LOS CONSEJOS  
PARA EL MONTAJE

PRIJE POČETKA MONTAŽE  
MOLIMO PAŽLJIVO  
PROČITAJTE UPUTE ZA  
MONTAŽU

BASLAMADAN ÖNCE,  
EKTEKI MONTAJ TALIMATLARINI  
İNCELEYİNİZ

PRE POČETKA MONTAŽE MOLIMO  
PAŽLJIVO PROČITAJTE UPUTSTVO  
ZA MONTAŽU

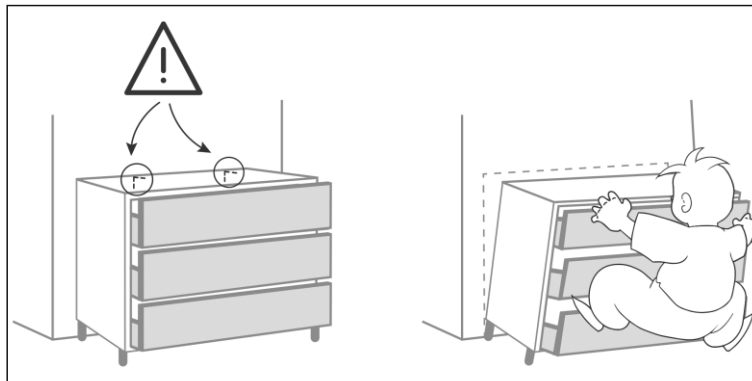

FRANCE	
CODE INFORMATIQUE	

SWITZERLAND	
CODE INFORMATIQUE	
INFORMATIK CODE	
CODICE INFORMATICO	

ESPANA	
CODIGO INFORMATICO	

Türkiye	
BİLGISAYAR KODU	

PORTUGAL	
CODEGO INFORMATICO	

ITALIA	
CODICE INFORMATICO	

HRVATSKA	
KOD	624312

SRBIJA	
ŠIFRA ARTIKLA	624312

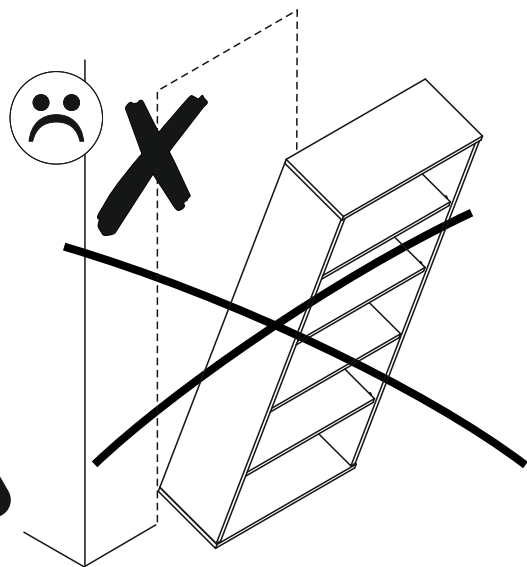
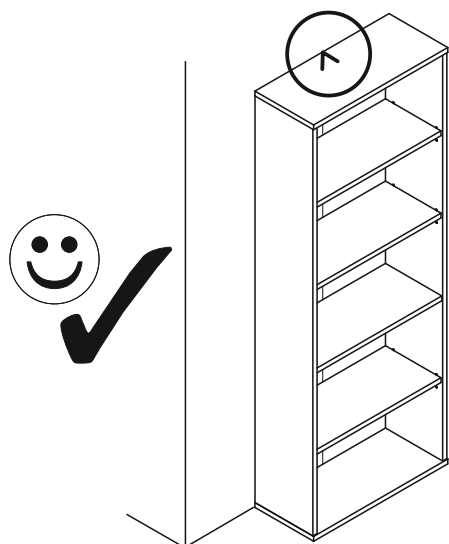

PL.

UWAGA! Mebel należy trwale zamocować do ściany, aby uniknąć ryzyka związanego z przewróceniem się mebla.

W paczce nie ma śrub mocujących, ponieważ rodzaj mocowania należy odpowiednio dobrać do rodzaju ściany. Dobierz właściwe do Twojego rodzaju ściany.

SK.

POZOR! Nábytok musí byť trvalo pripevnený k stene tak, aby sa zamedzilo riziku prevrátenia.

Balík neobsahuje upevňovacie skrutky, pretože typ upevnenia je treba vybrať podľa typu steny. Vyberte typ vhodný pre Vašu stenu.

FR.

ATTENTION! Ce meuble doit être fixé en permanence au mur pour éviter les risques de chute. Les vis de fixation ne sont pas livrées car le type de fixation doit être choisi en fonction du type de mur. Sélectionnez les fixations adaptées au mur.

HU.

FIGYELEM! Rögzítse a bútorokat a falhoz, hogy elkerülje a bútor felborulásának kockázatát. A készletben nem találhatóak rögzítőcsavarok, mivel a rögzítés típusa a fal típusától függ. Válassza ki a fal típusának megfelelő kötőelemeket.

HR.

NAPOMENA! Namještaj mora biti trajno pričvršćen za zid, kako bi se izbjegao rizik od njegova prevrtanja. U paketu nema vijaka za pričvršćivanje, jer se vrsta montaže mora prilagoditi vrsti zida. Odaberite pravu vrstu prema Vašoj vrsti zida.

EN.

WARNING! To prevent this furniture from tripping over, fix it to the wall permanently. Fixing devices are not included since different wall materials require different types of fixing devices. Please make sure you chose the correct ones for your type of wall.

D.

ACHTUNG! Um alle mit dem Umkippen des Möbels verbundenen Risiken auszuschließen, muss das Möbel fest an der Wand verankert werden. Beschläge für die Wandbefestigung sind nicht beige packt, da diese von der jeweiligen Wandbeschaffenheit abhängig sind. Bitte solche Befestigungsschläge wählen, die für die heimischen Wände geeignet sind.

CZ.

POZOR! Nábytek je nutné pevně připevnit ke zdi, abychom se vyhnuli riziku spojenému s jeho převrnutím. Součástí balení nejsou připevňovací šrouby, protože způsoby připevnění je nutné zvolit podle druhu stěny. Vyberte správný pro Váš typ stěny.

E.

¡ATENCIÓN! El mueble debe ser fijado permanentemente a la pared para evitar el riesgo relacionado con el vuelco del mueble. En el paquete no hay tornillos de fijación, ya que se debe elegir el tipo de fijación adecuado para el tipo de pared. Elija el apropiado para su tipo de pared.

CN.

注意！本家具需要固定在墙上以免倒塌。箱子里没有安装螺钉。因为安装方式需要根据墙的类型调整。请按照您的墙类型选择合适的安装方式。

RU.

ПРИМЕЧАНИЕ! Эту мебель необходимо всегда прикреплять к стене, чтобы избежать рисков, связанных с переворотом мебели. В пакете нет крепежных винтов, потому что тип крепления должен быть выбран в соответствии с типом стены. Выберите, пожалуйста, правильные винты к вашей стене.









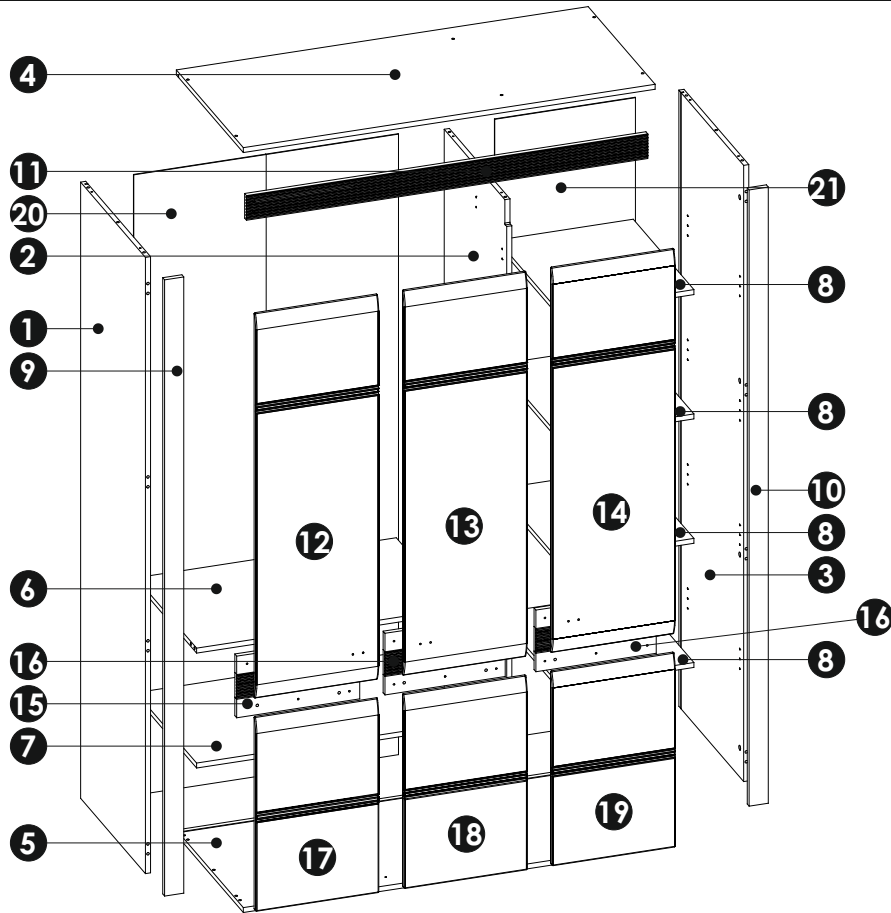



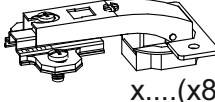















SLO.

POZOR! Pohištvo trajno pritrdite na steno, da preprečite tveganje, da se prevrne. V paketu ni pritrdilnih vijakov, saj je treba način pritrditve ustrezno izbrati glede na vrsto stene. Izberite način, ki je ustrezen za vašo steno.

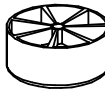
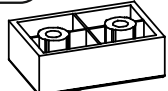
I.

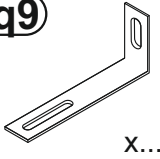
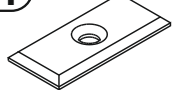
ATTENZIONE! Il mobile deve essere permanentemente fissato alla parete per evitare i rischi derivanti da un ribaltamento del mobile. La confezione non include le viti di fissaggio, in quanto il tipo di fissaggio deve essere scelto in base al tipo di parete. Utilizzare viti appropriate in base al materiale della parete.

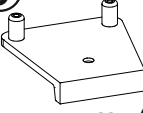

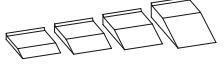
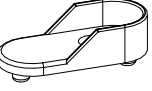
<b>a0</b>  8x20 x...(x12)	<b>a1</b>  8x35 x...(x32)	<b>b0 + b2a</b>  x...(x4)	<b>b0 + br3</b>  x...(x8)	<b>c1</b>  Euro 4x13 x...(x24)	<b>d2</b>  x...(x20)	<b>dr</b>  L-805 x...(x1)	<b>e0</b>  x...(x12)		
<b>e1</b>  x...(x12)	<b>f1</b>  x...(x12)	<b>g0</b>  x...(x12)	<b>g1</b>  7x50 x...(x12)	<b>h1</b>  x...(x3)	<b>i2</b>  4x16 x...(x2)	<b>i4</b>  4x27 x...(x4)	<b>i10</b>  3,5x22 x...(x8)	<b>j2</b>  4x25 x...(x18)	<b>j9</b>  3,5x27 x...(x2)
<b>k3</b>  M4x22 x...(x6)	<b>m</b>  x...(x1)	<b>n0</b>  3x13 x...(x1)	<b>n1</b>  3x16 x...(x15)	<b>n2</b>  3,5x16 x...(x8)	<b>o1</b>  x...(x2)	<b>o2</b>  x...(x4)	<b>p16</b>  x...(x18)		
<b>q9</b>  x...(x2)	<b>r1</b>  x...(x13)	<b>r4</b>  x...(x16)	<b>r5</b>  x...(x1)	<b>r8</b>  x...(x6)	<b>w</b>  x...(x3)	<b>z</b>  x...(x1)			
<b>z1</b>  x...(x2)									

- 1**
- a1** 8x35 x10
- d2** x2
- e1** x4
- f1** x2
- n2** 3,5x16 x1
- z1** x1

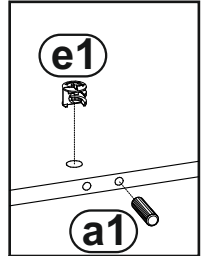
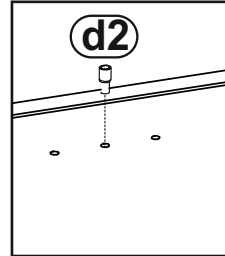
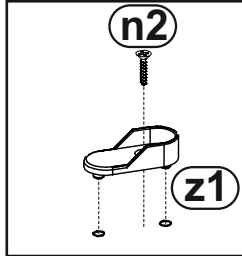
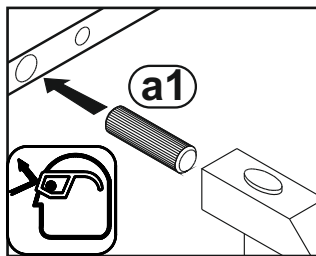
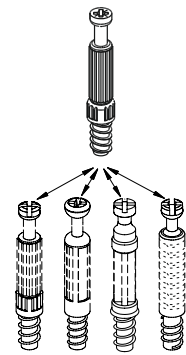
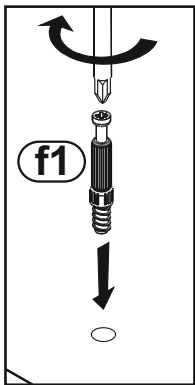
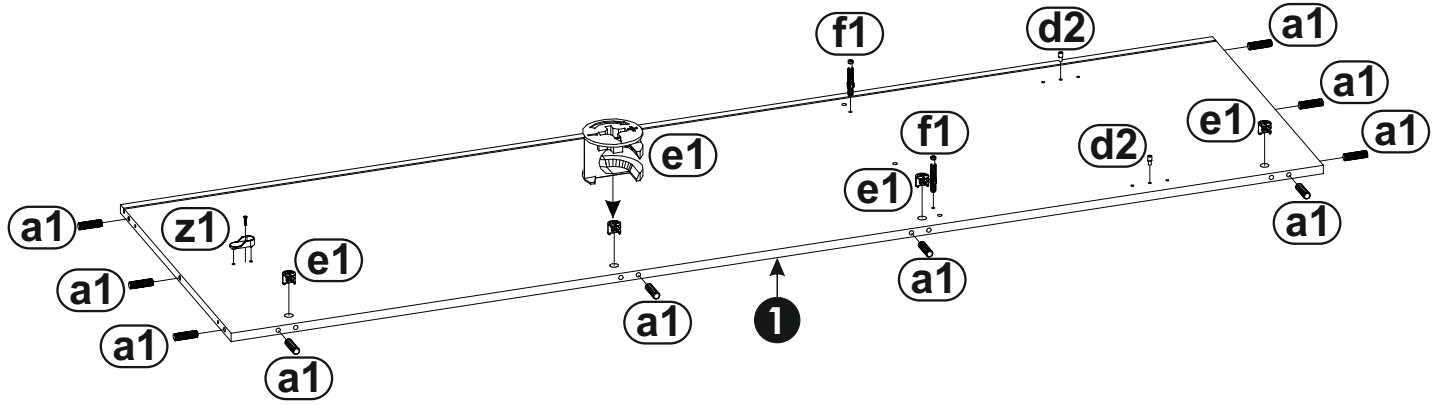

- 2**
- a1** 8x35 x6
- b0** x4
- d2** x10
- f1** x2
- n2** 3,5x16 x1
- z1** x1

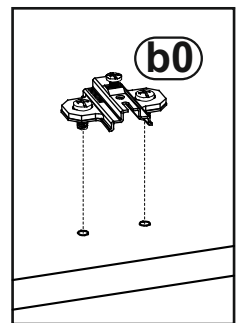
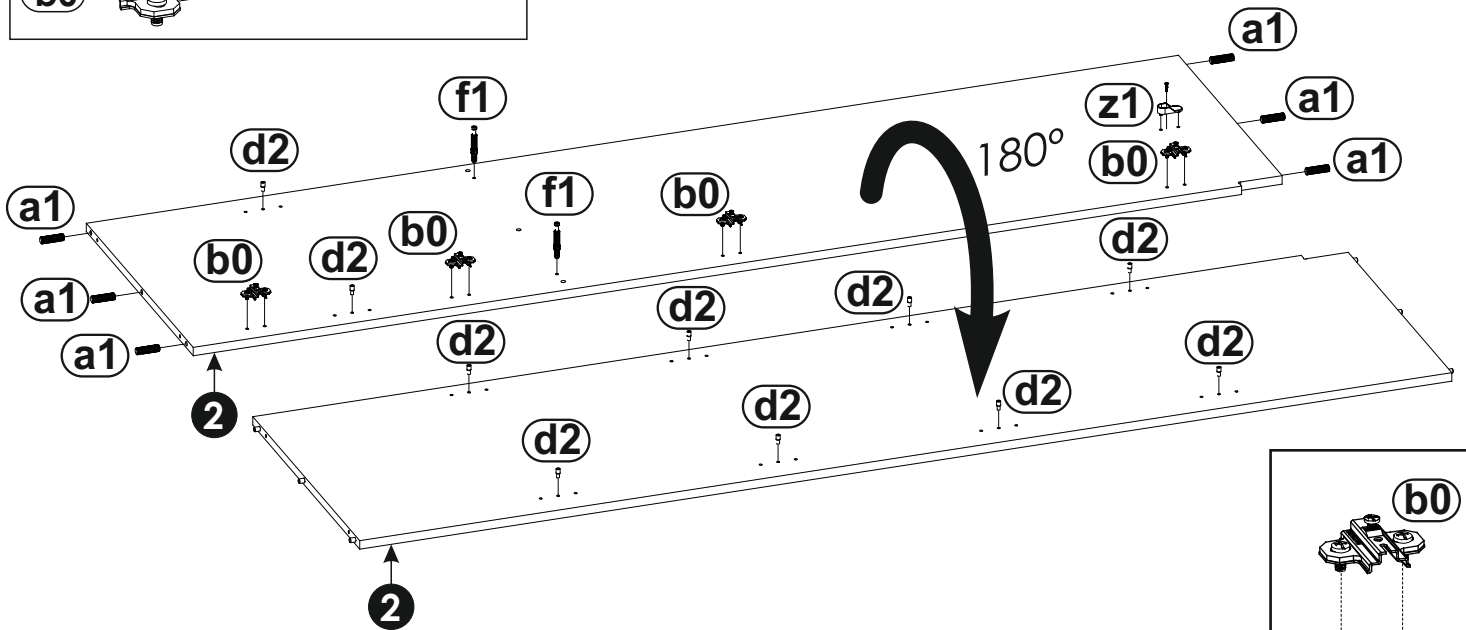
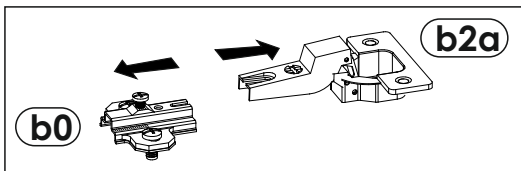

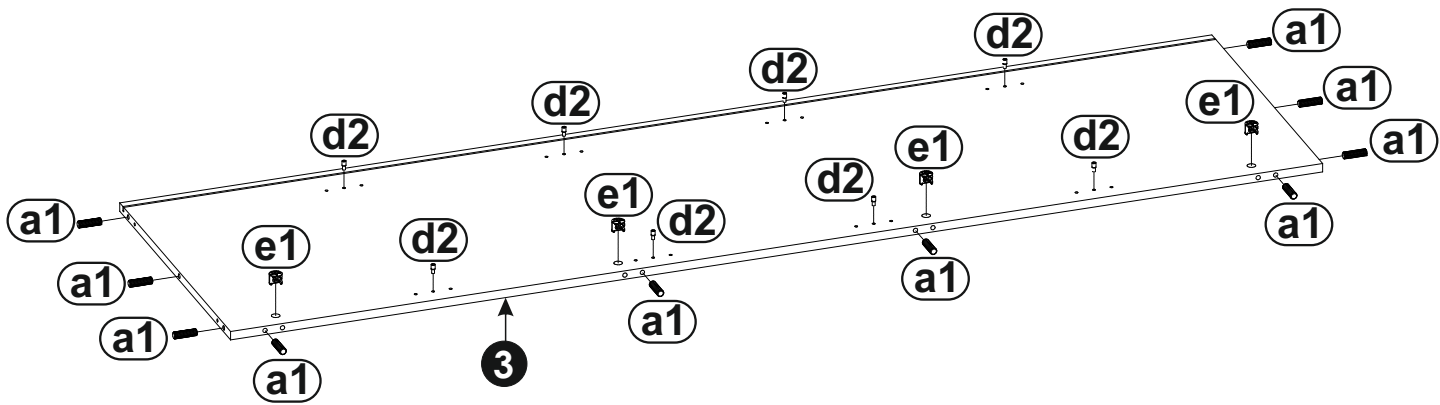

<b>3</b>	<b>a1</b> 8x35 x10	<b>d2</b> x8	<b>e1</b> x4
----------	--------------------------	-----------------	-----------------



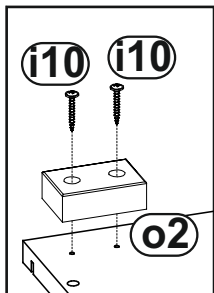
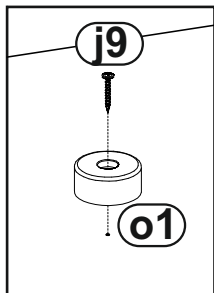
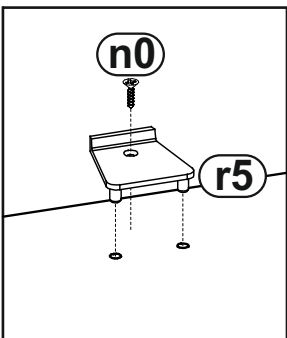
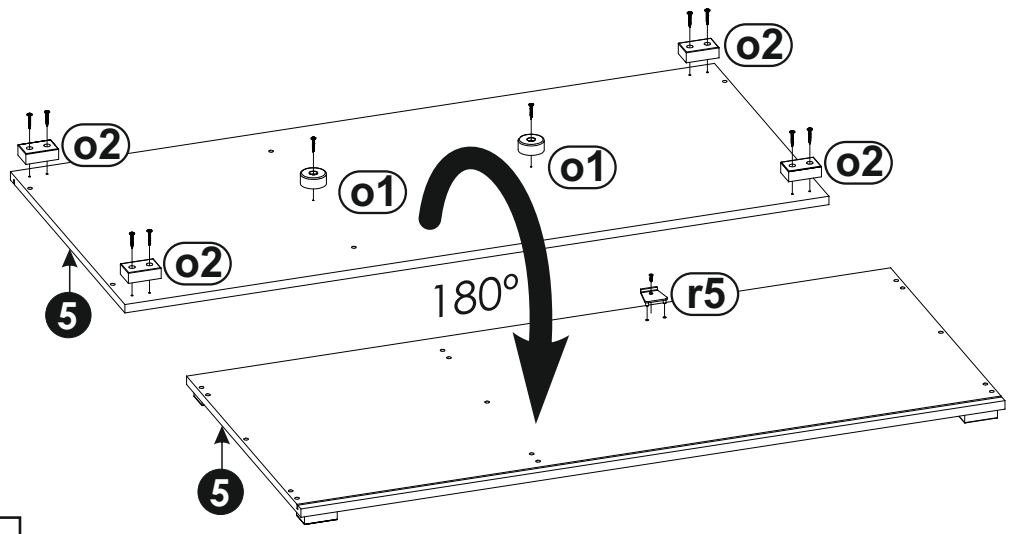

<b>4</b>	<b>i10</b> 3,5x22 x8	<b>j9</b> 3,5x27 x2	<b>n0</b> 3x13 x1	<b>o1</b> x2	<b>o2</b> x4	<b>r5</b> x1
----------	----------------------------	---------------------------	-------------------------	-----------------	-----------------	-----------------



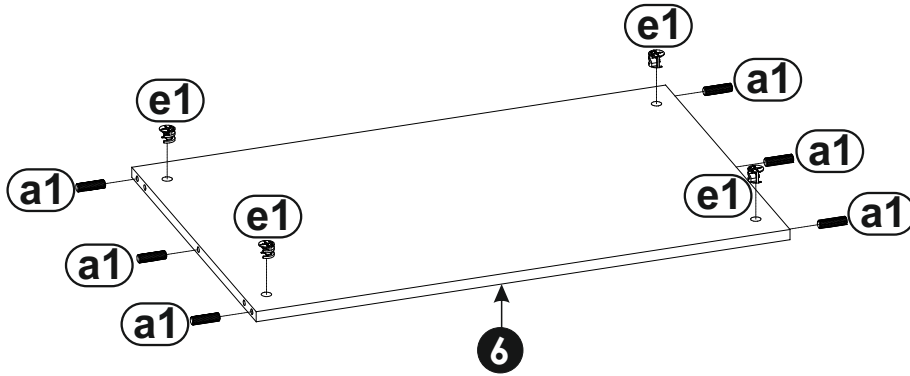

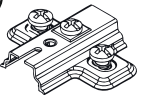
<b>5</b>	<b>a1</b>	<b>e1</b>
	 8x35 x6	 x4



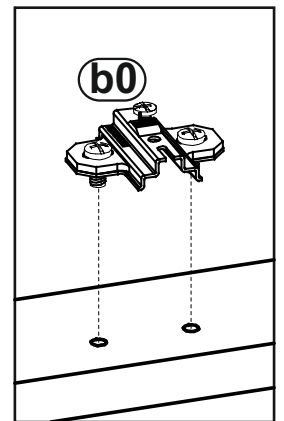
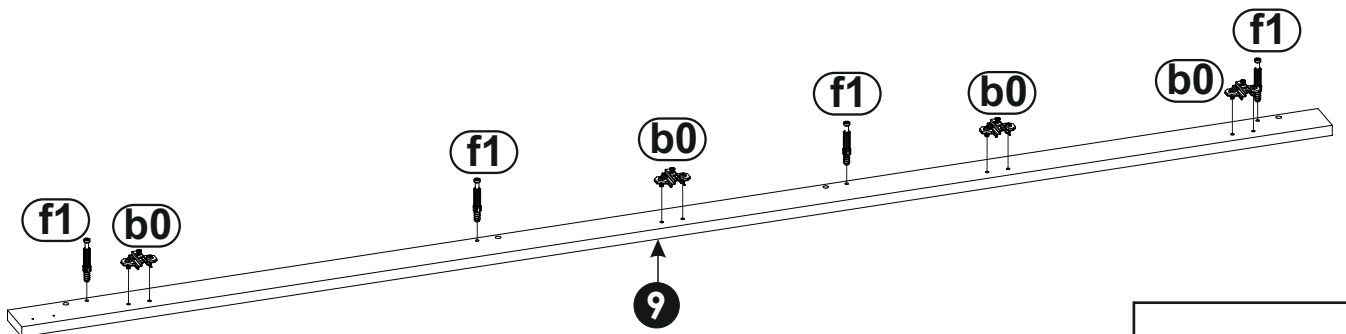
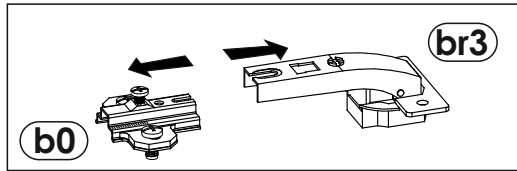

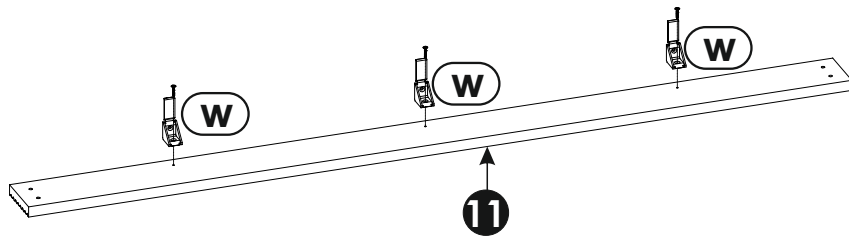
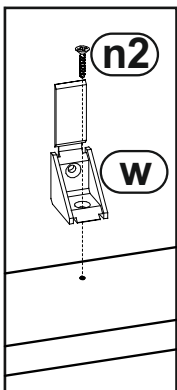
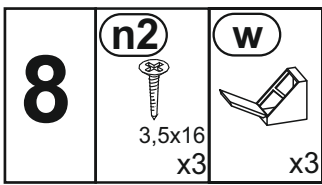
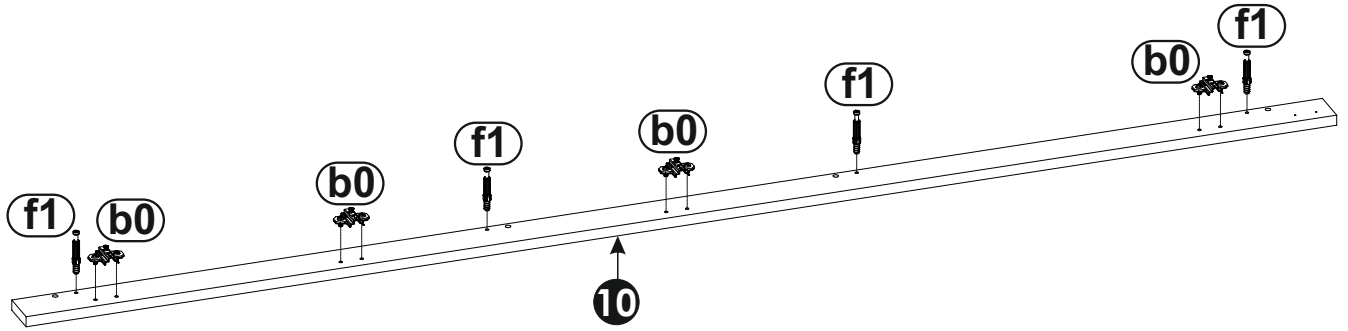
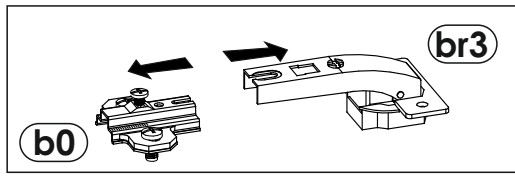
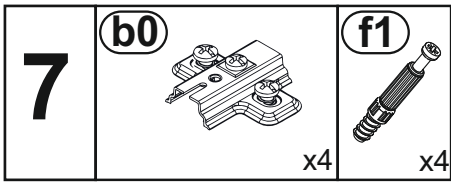

<b>6</b>	<b>b0</b>	<b>f1</b>
	 x4	 x4



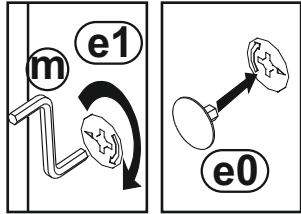
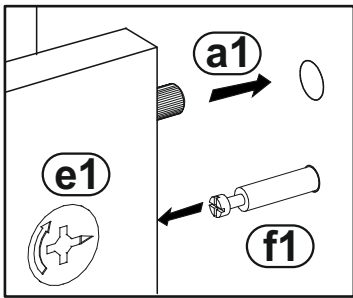
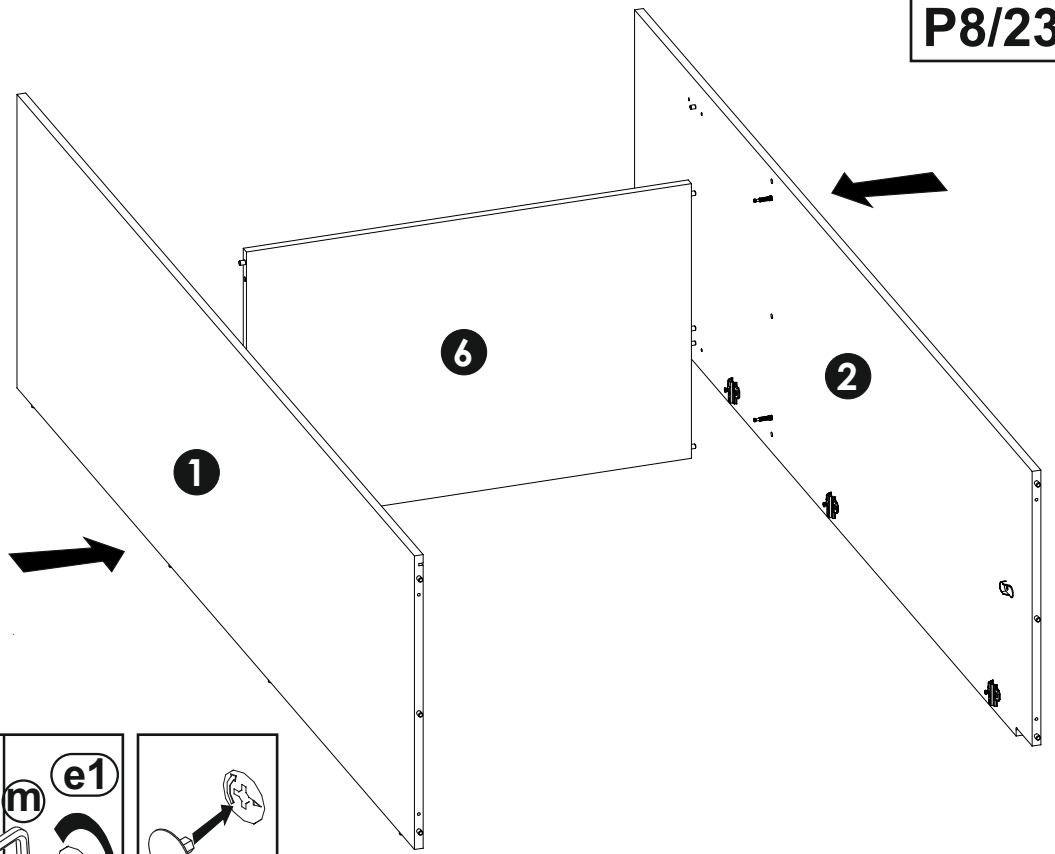

<b>9</b>	<b>e0</b>	<b>m</b>
	 x4	 x1



<b>10</b>	<b>g0</b>	<b>g1</b>	<b>m</b>
	 x6	 7x50 x6	 x1

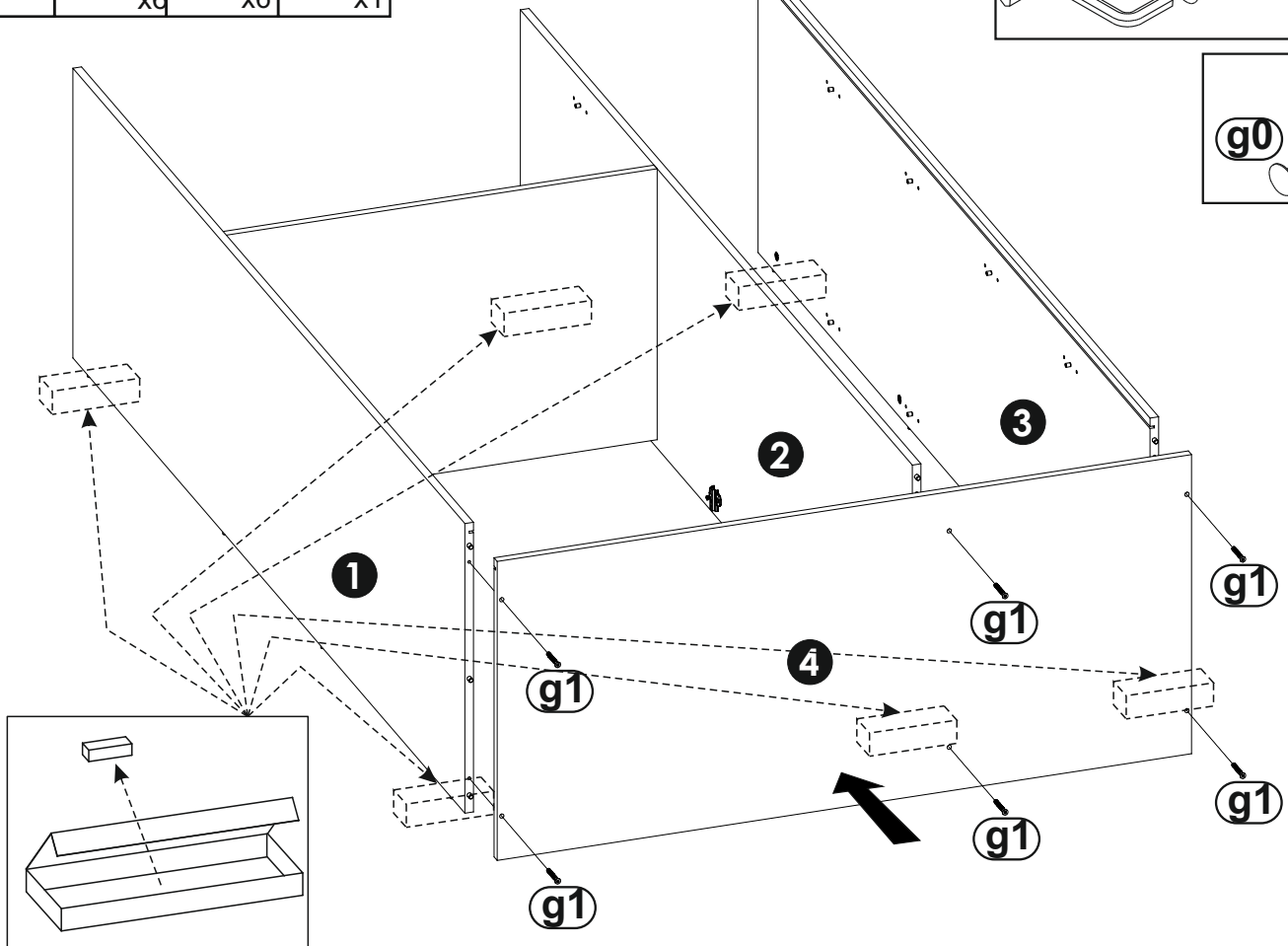
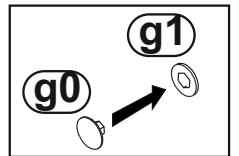
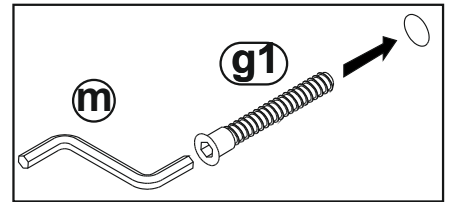



11

P9/23

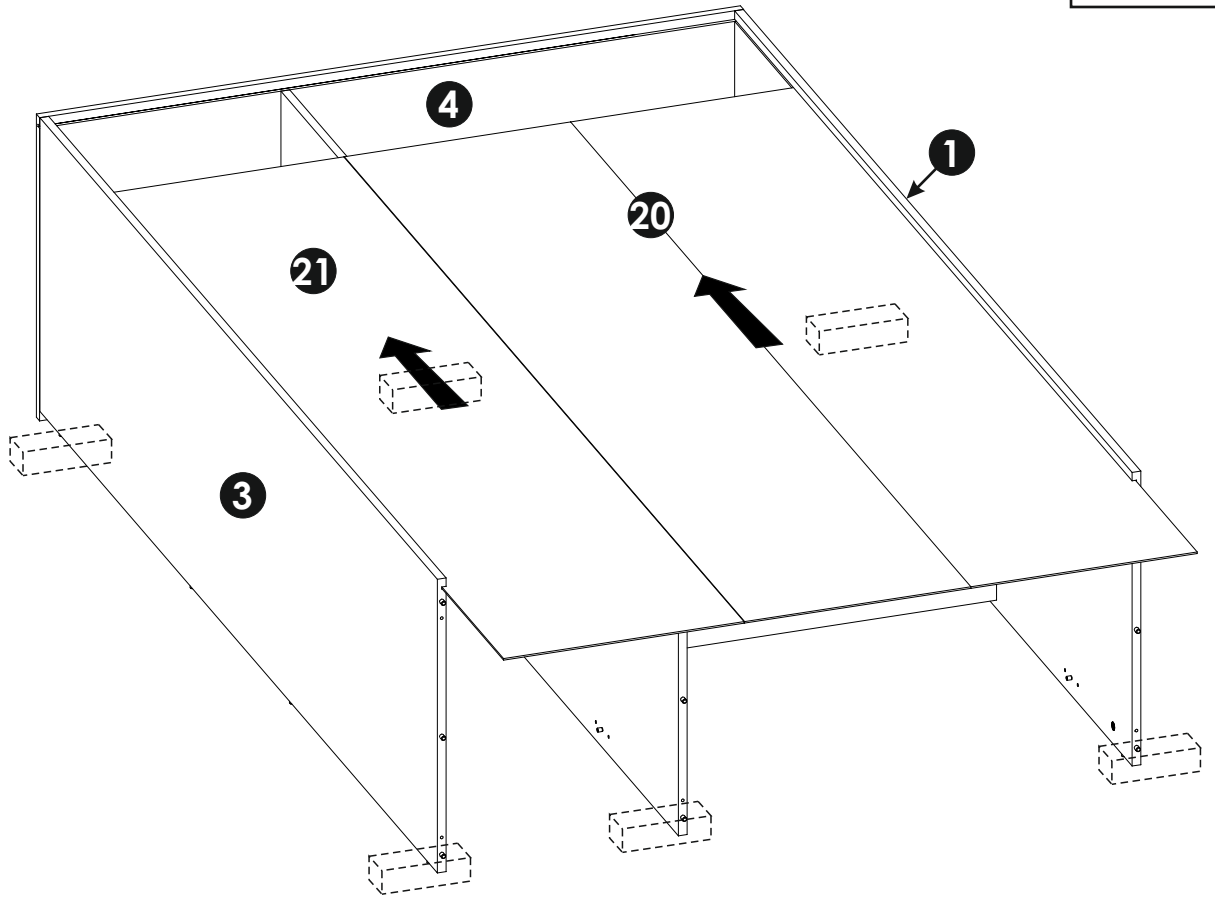

12

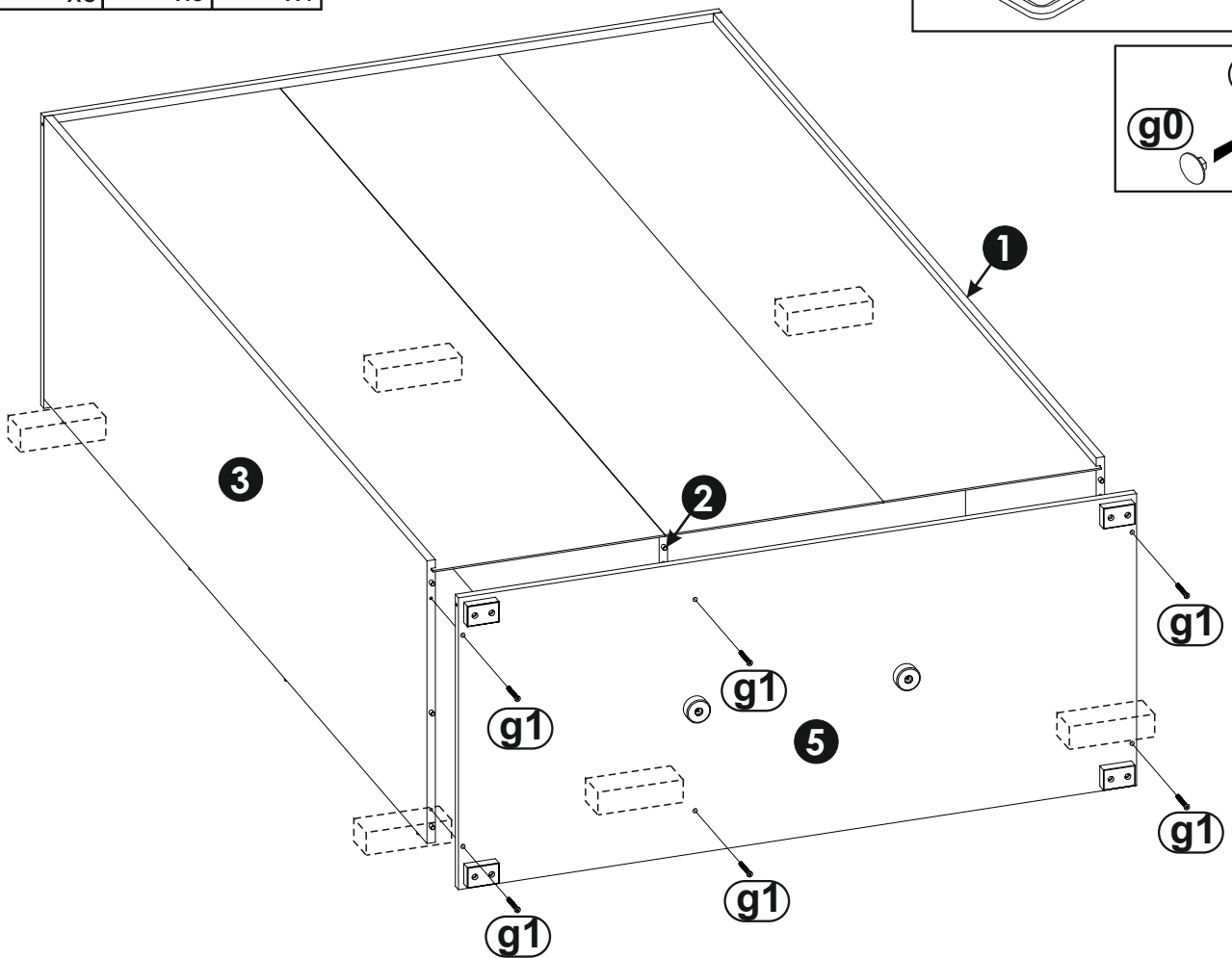
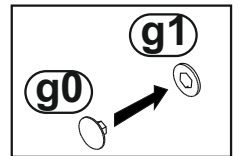
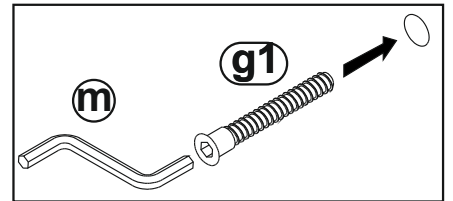
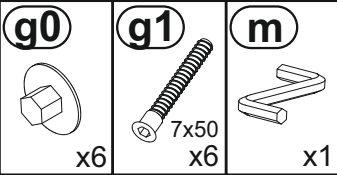

13

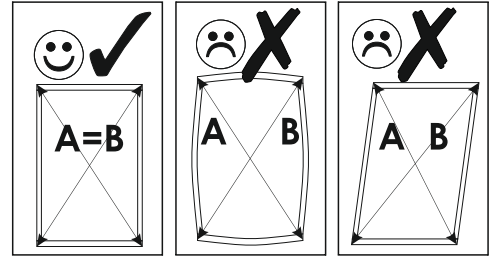
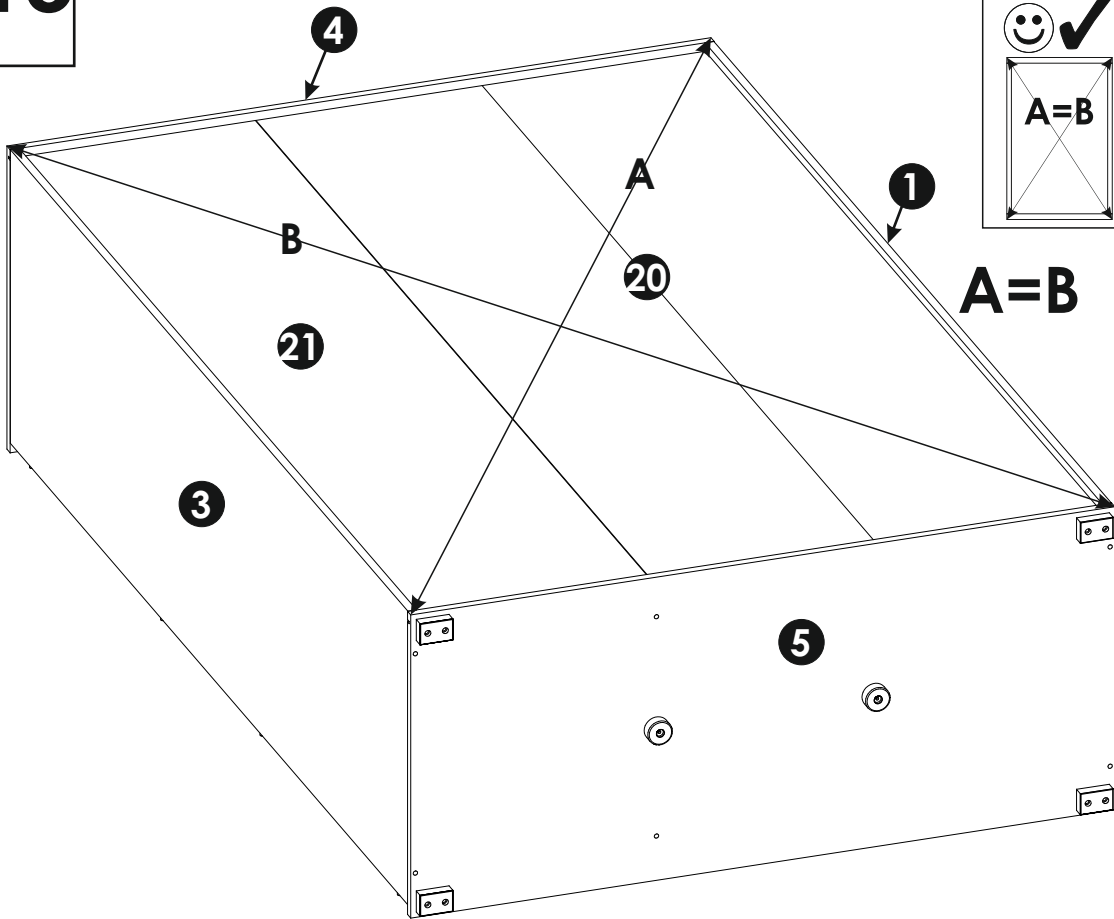

P10/23

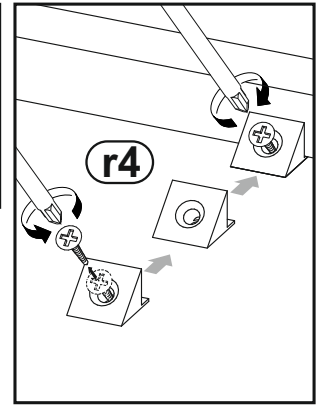
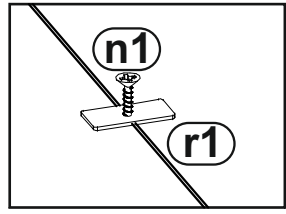
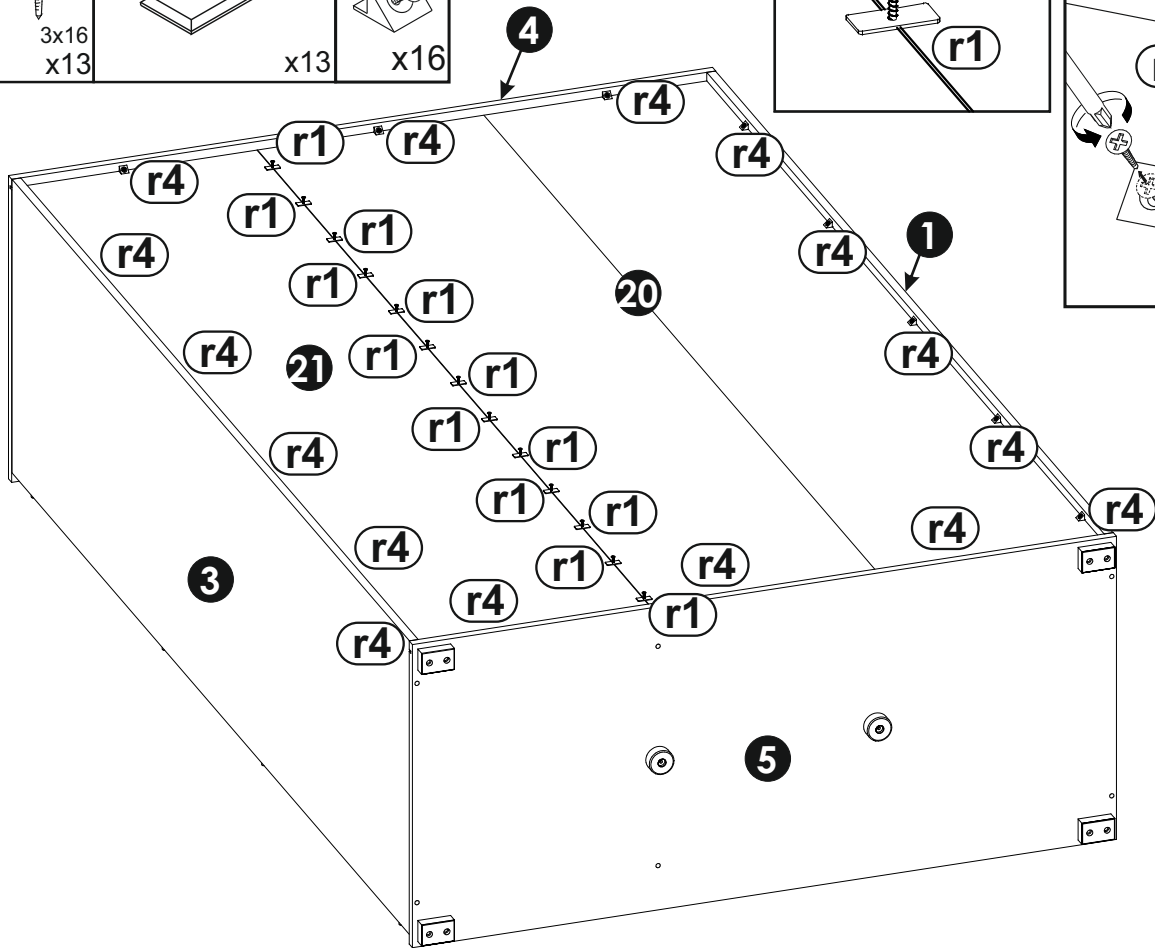
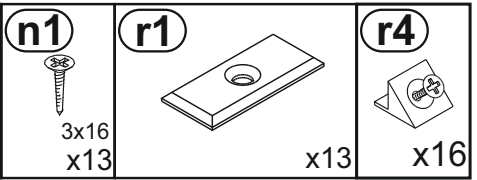

14

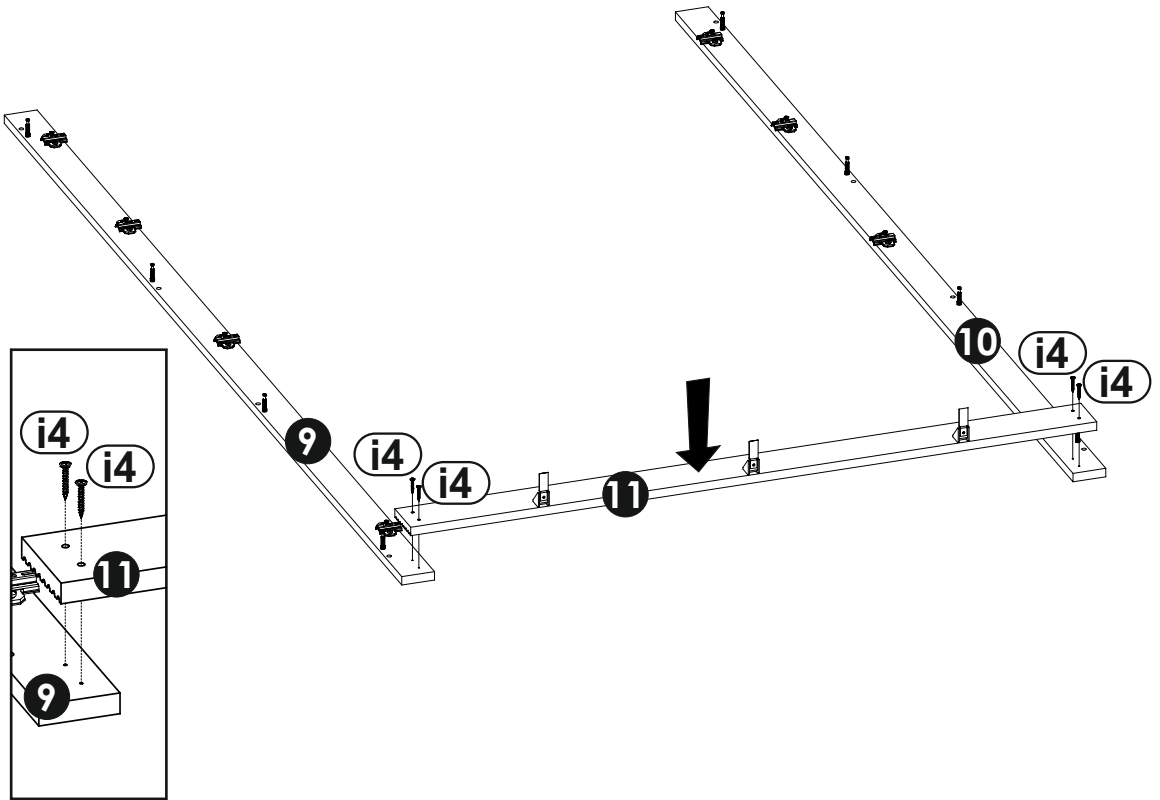

**15** **i4**  
4x27  
x4



**16** **e0** **m**  
x8 x1

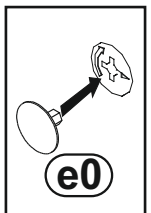
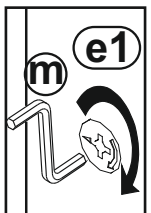
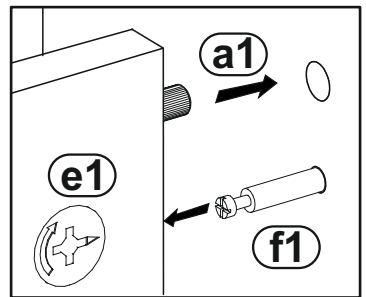
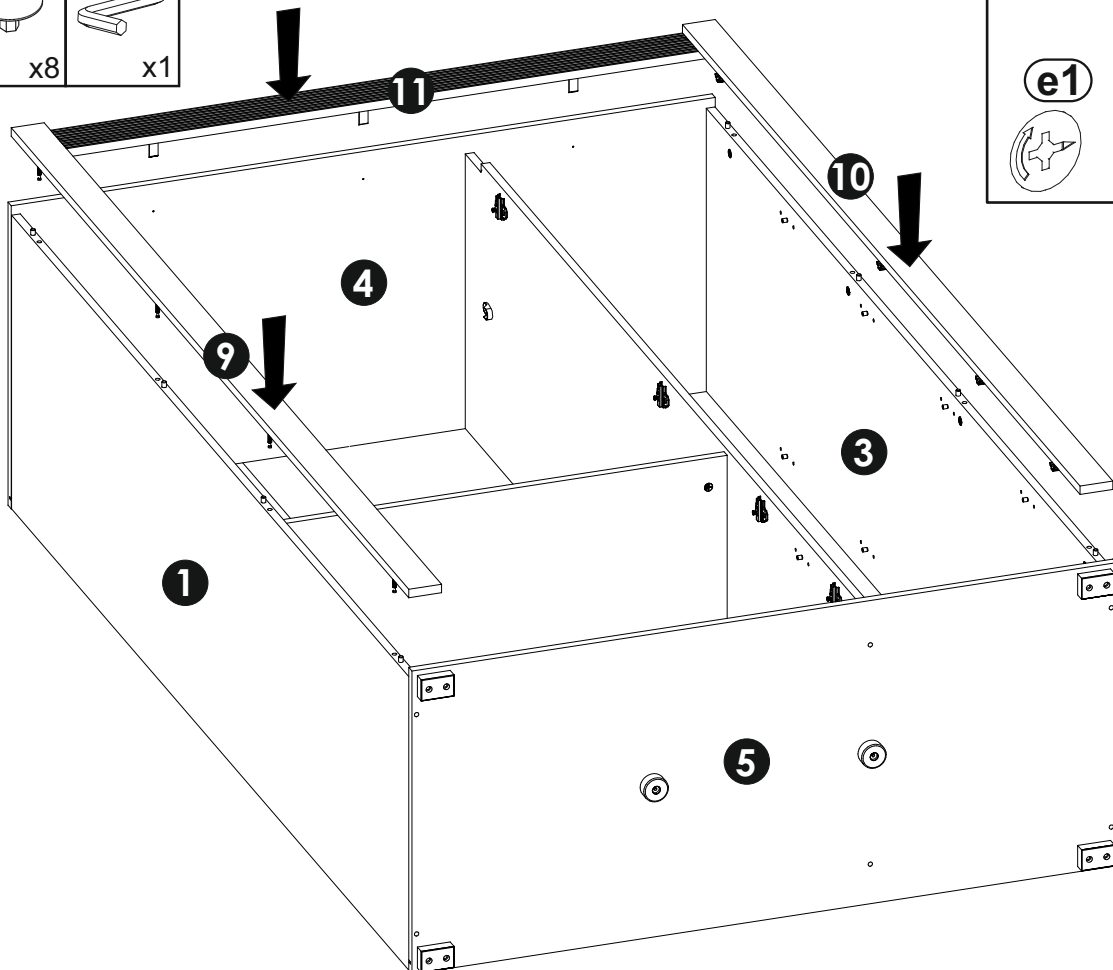
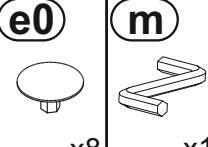

17

n2

3,5x16  
x3

P12/23

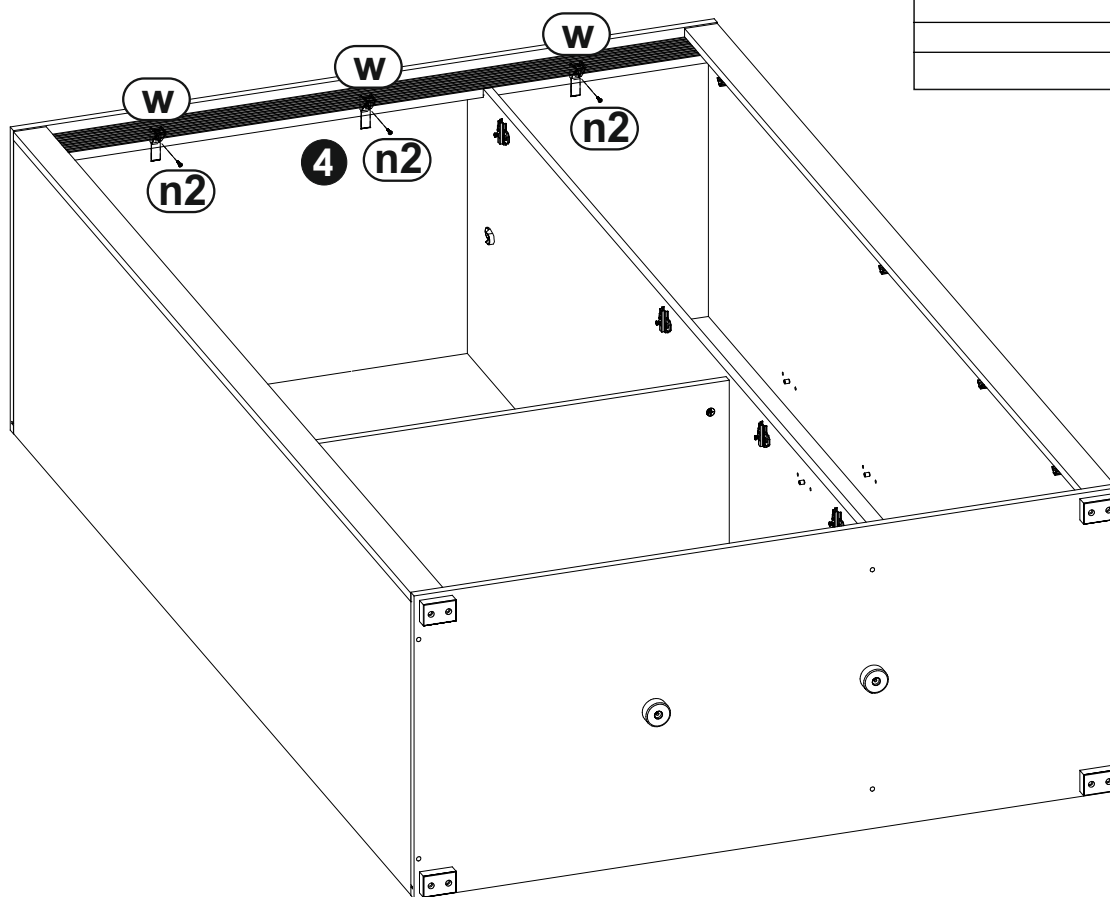
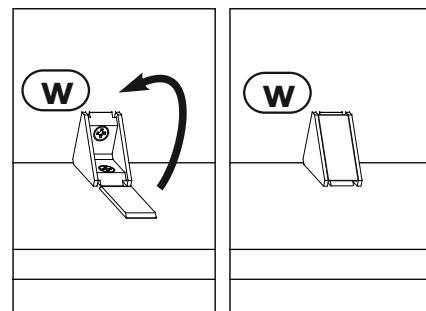
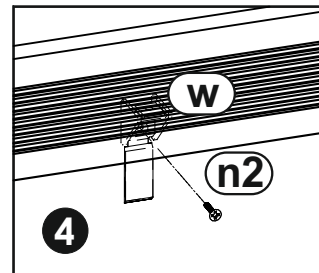

# 18

i2



q9

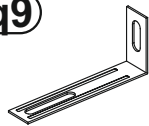

x2

Z

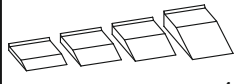

x1

P13/23

A

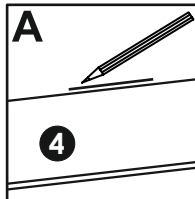

B

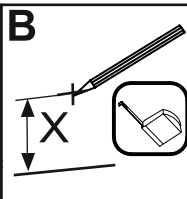

C

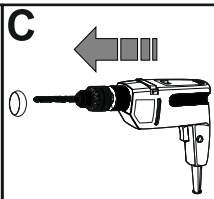

D

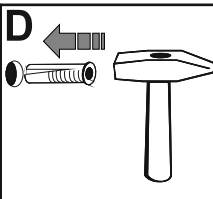

E

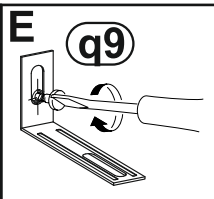

F

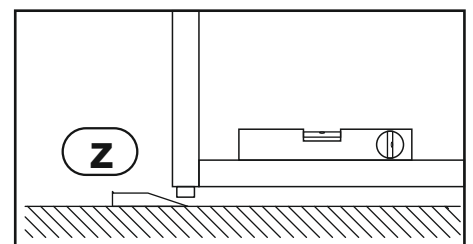
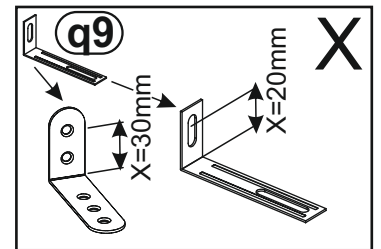
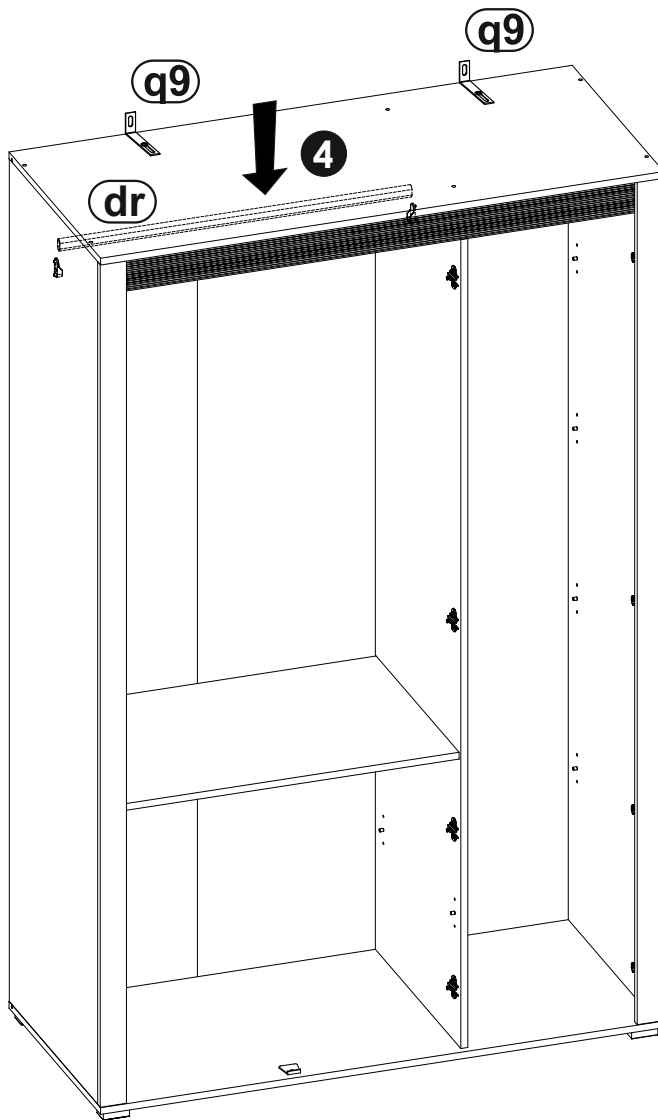
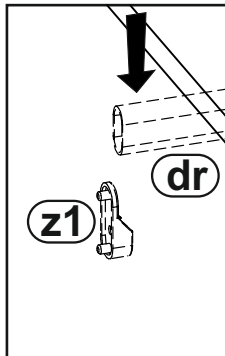
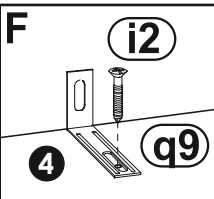

HR

**VAŽNO:** Da bi se izbjeglo slučajno tip-over namještaja, učvršćivanje namještaja na zid je obavezno.

Potreban hardver za spoj zida / namještaja, ovisno o prirodi zida,

Nije navedeno.

Ako imate bilo kakve sumnje,

SRB

**VAŽNO:** Da biste izbegli slučajno prevrtanja nameštaja, za fiksiranje na nameštaja na zid je obavezna.

Potreban hardver za spoj zida / nameštaj, u zavisnosti od prirode zida, je

nije obezbeđeno.

Ako ikakve sumnje, obratiti se lekaru.

19

P14/23

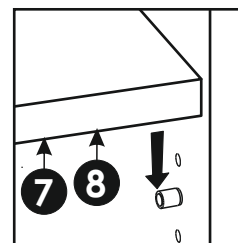
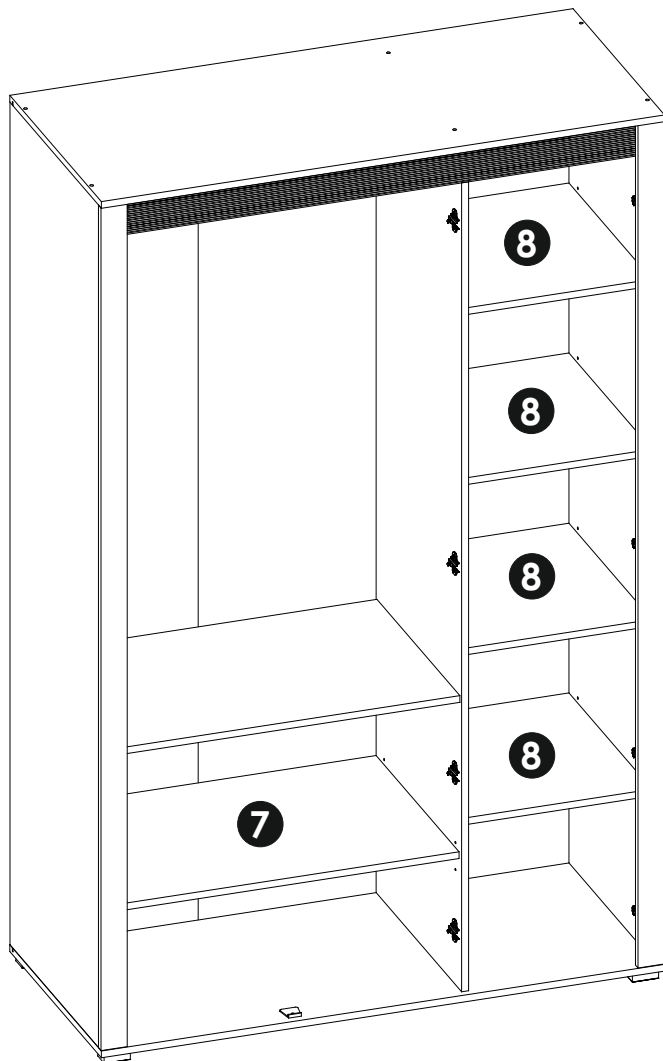

20

a0



8x20  
x4

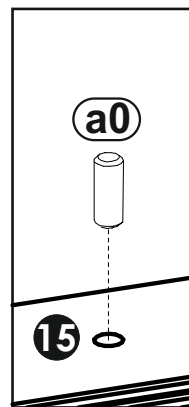
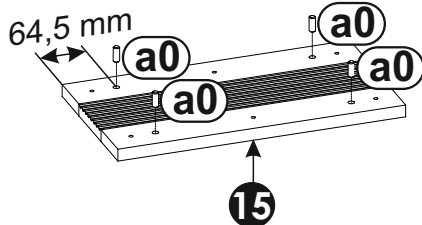

21

a0



8x20  
x8

P15/23

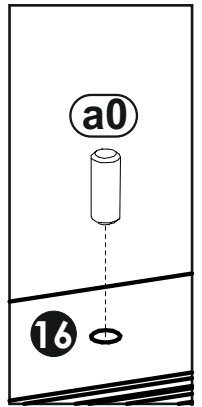
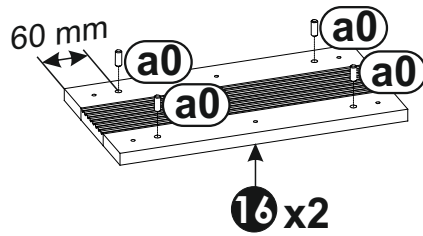

22

j2

p16



4x25  
x6

x6

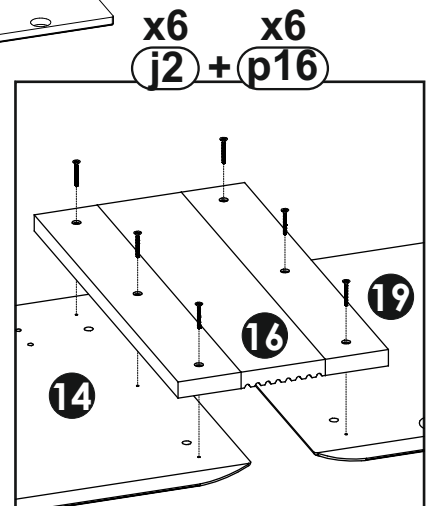
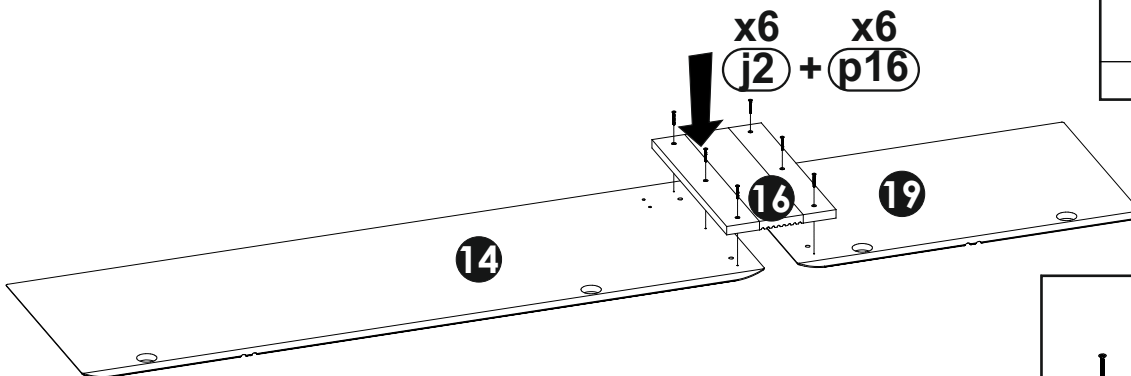
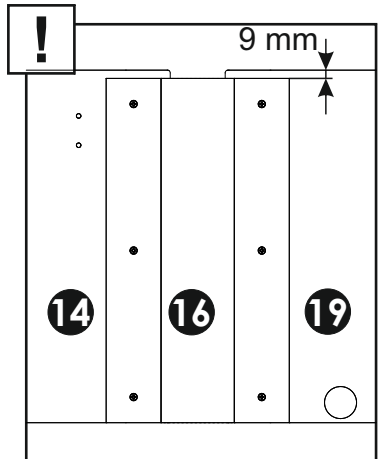

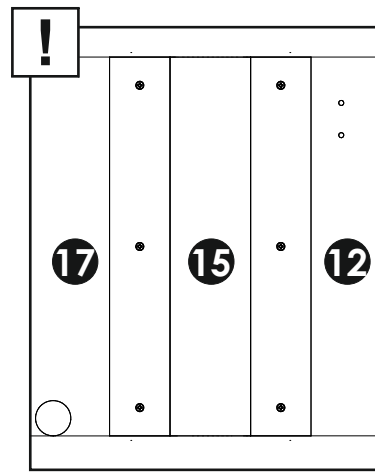
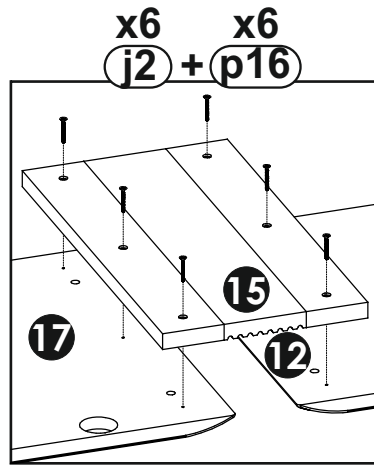
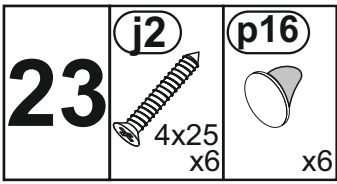

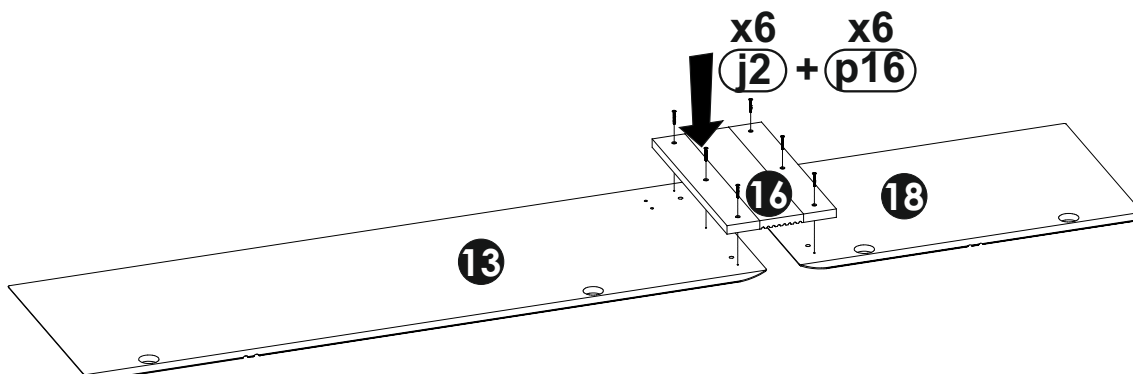
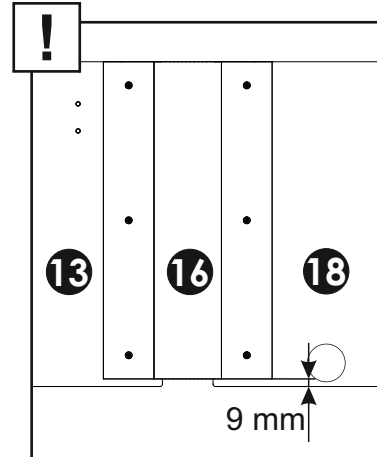
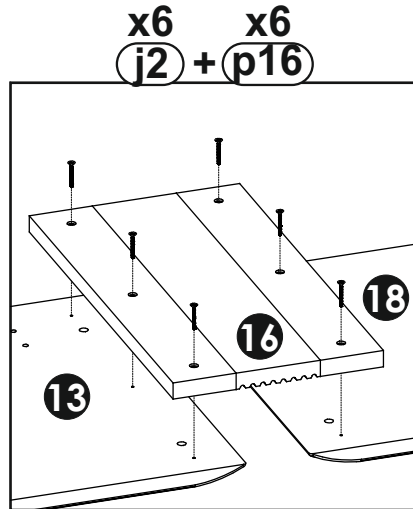
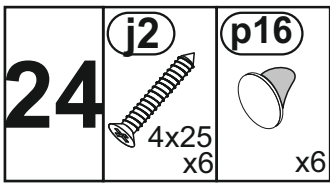
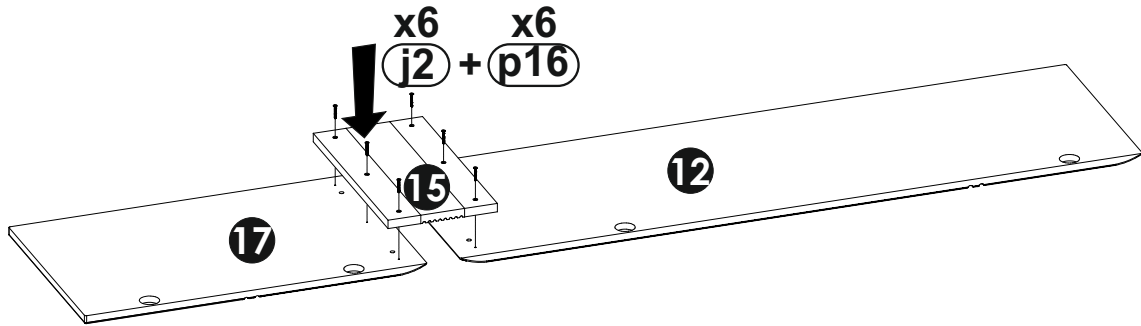

**P16/23**



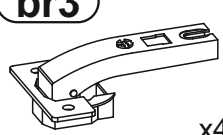

25

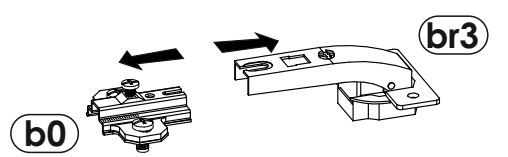

<b>br3</b>  x4	<b>c1</b>  Euro 4x13 x8	<b>r8</b>  x2
--	--	--

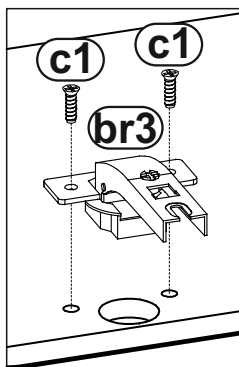
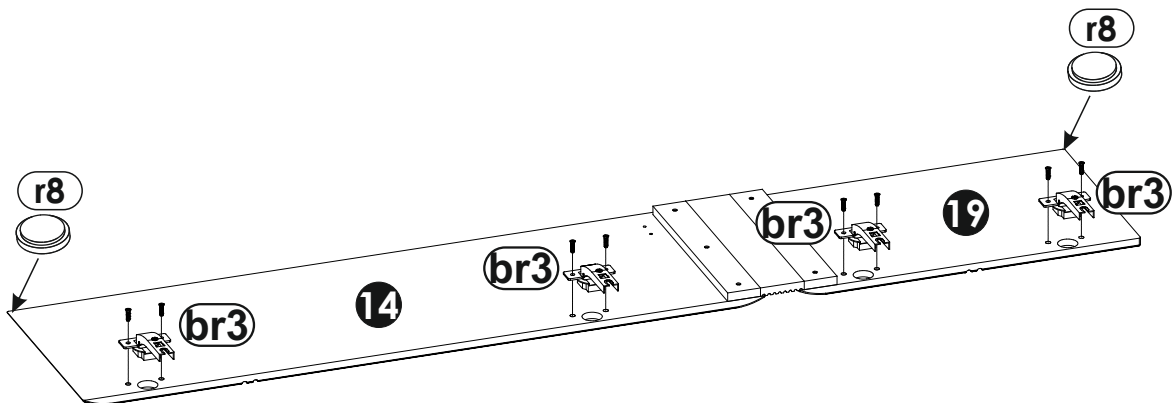

**b0** **br3**

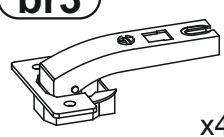

26

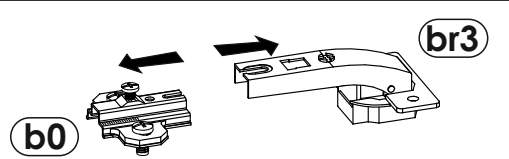

<b>br3</b>  x4	<b>c1</b>  Euro 4x13 x8	<b>r8</b>  x2
---	---	--

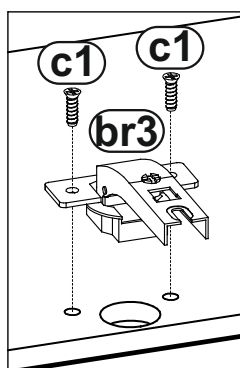
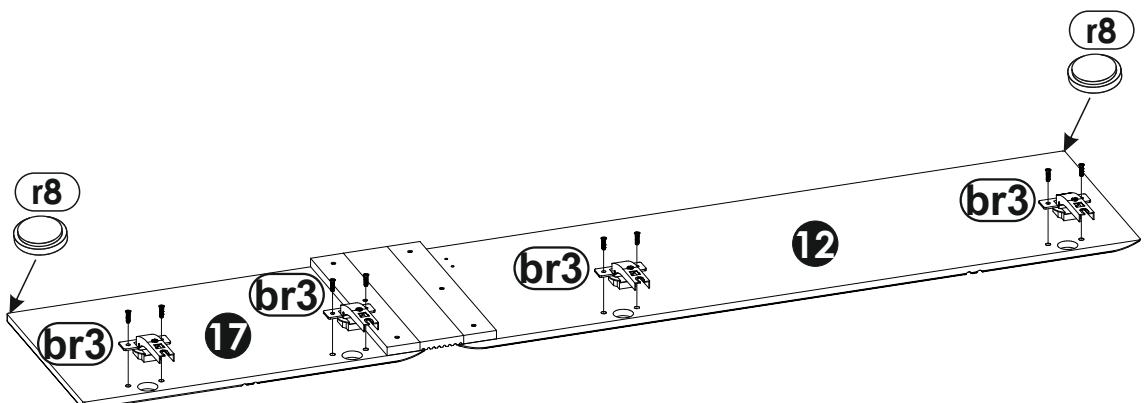

**b0** **br3**



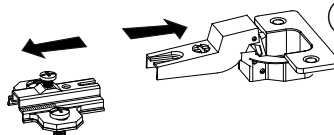

27

<b>b2a</b>  x4	<b>c1</b>  Euro 4x13 x8	<b>r8</b>  x2
---	---	--

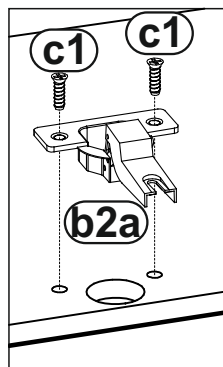
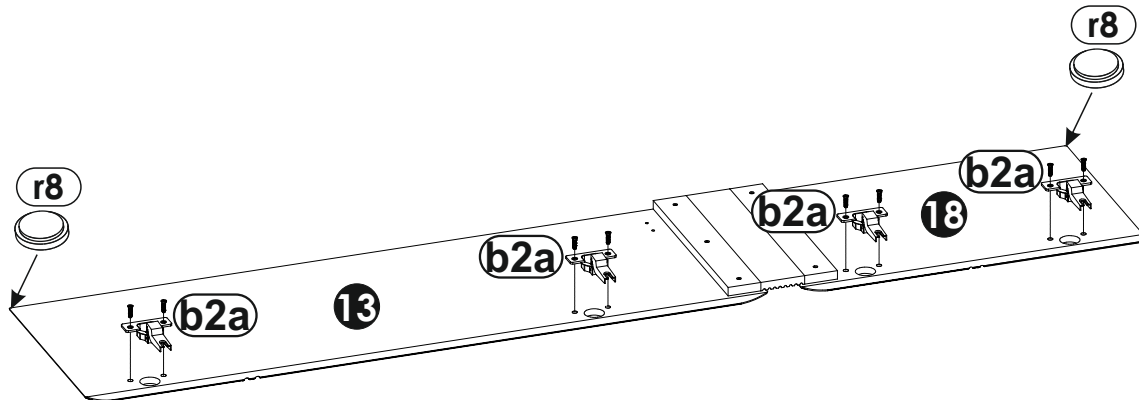
**b0**  **b2a**



28

1  

12 13 14 17 18 19

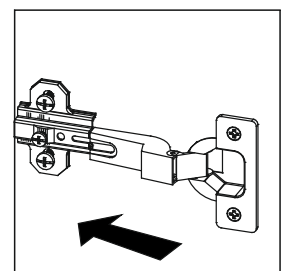
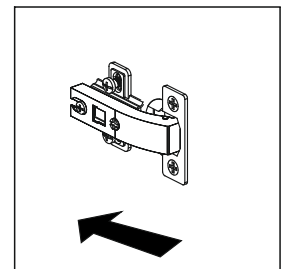
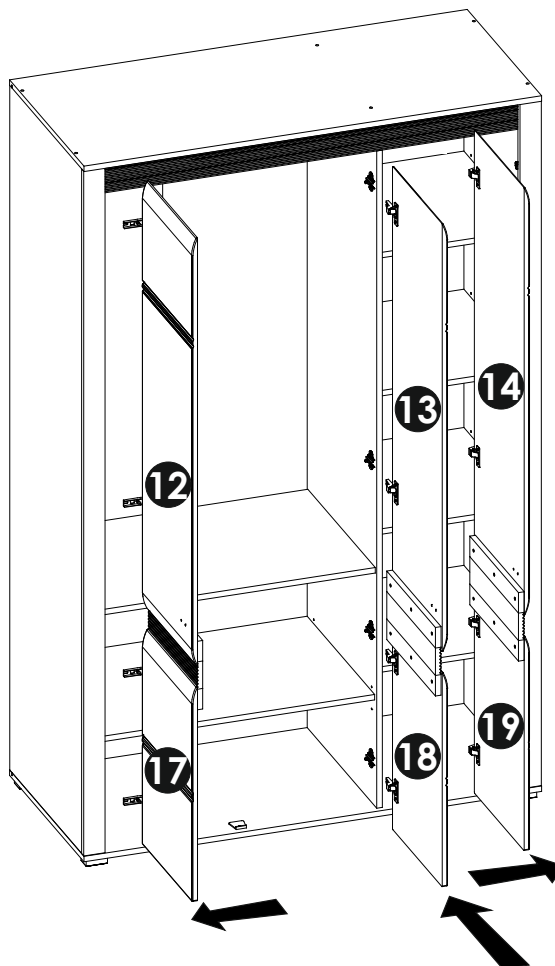

29

h1



x3

k3



M4x22  
x6

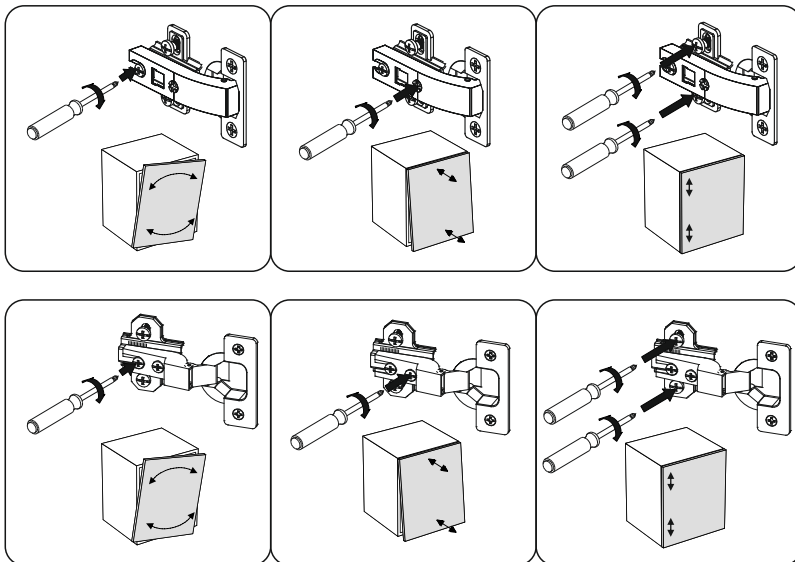
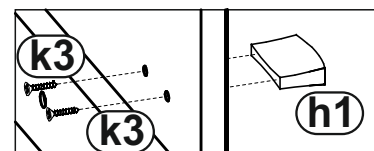
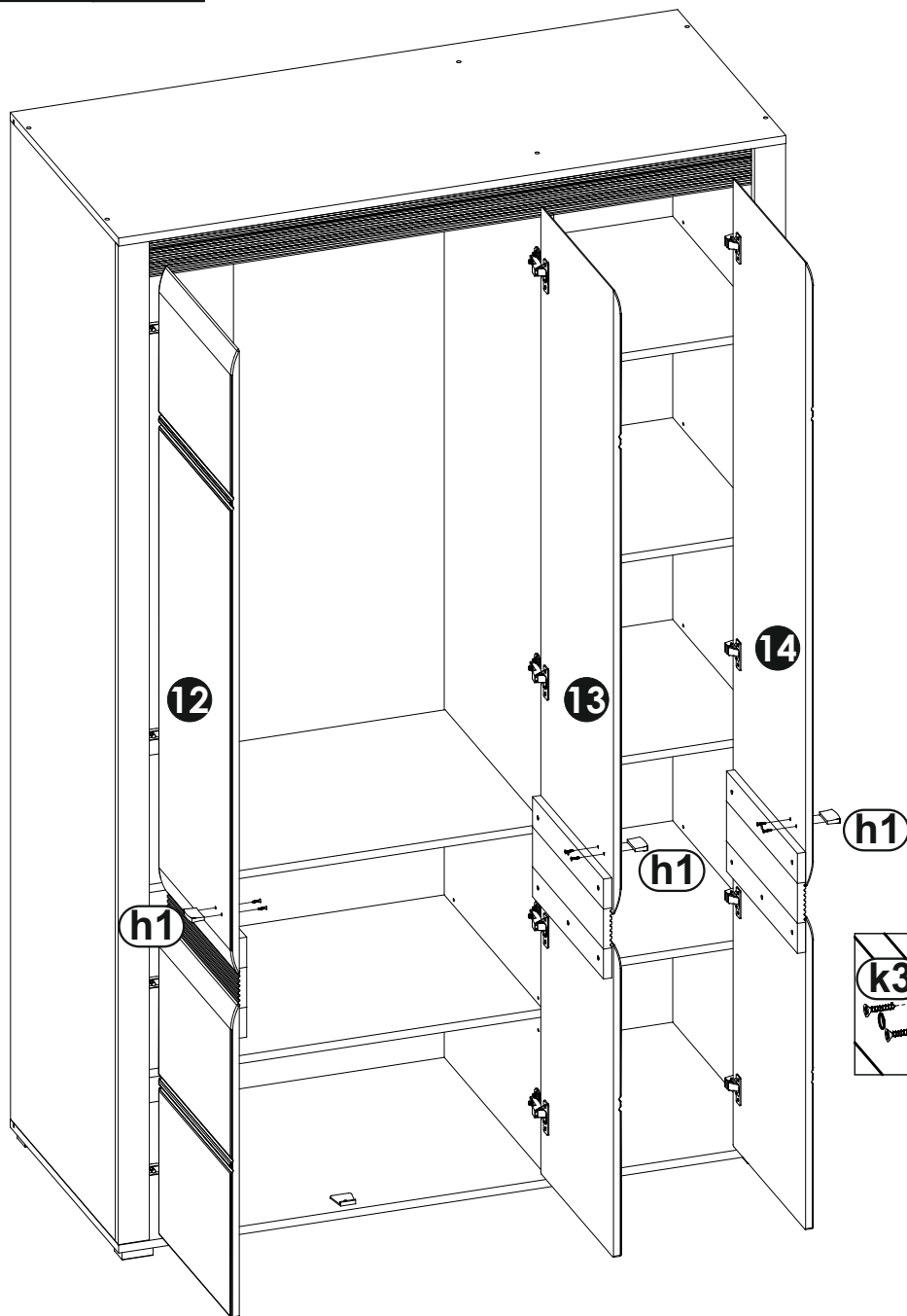

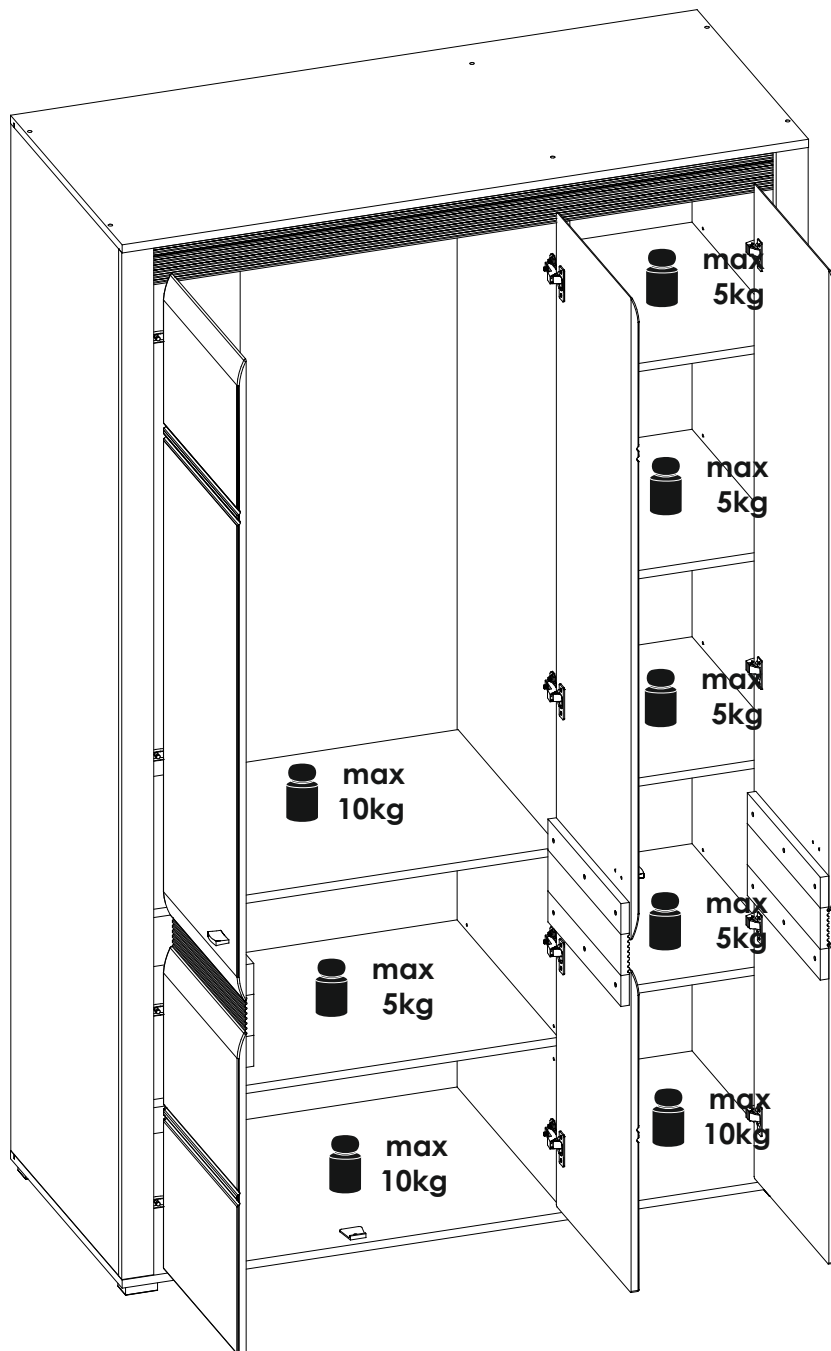

# emmezeta

## FRANCAIS - SUISSE

### CONSEILS DE MONTAGE :

- 1 > BIEN ETUDIER LA NOTICE DE MONTAGE.
- 2 > REPEREZ LES PIÈCES CONSTITUANT VOTRE MEUBLE.
- 3 > REGROUPEZ ET CONTROLEZ LA QUINCAILLERIE.
- 4 > MUNISSEZ-VOUS DE L'OUTILLAGE NECESSAIRE.
- 5 > AMENAGEZ-VOUS UNE ZONE DE MONTAGE.
- 6 > PROCEDEZ AU MONTAGE.



**NE JAMAIS FORCER LES ASSEMBLAGES. RESERRER LES VIS APRES QUELQUES TEMPS D'USAGE. GARDER VOTRE NOTICE DE MONTAGE, SI UNE PIÈCE VENAIT A MANQUER, ELLE SERAIT LE PLUS CLAIR MOYEN DE COMMUNIQUER AVEC VOTRE MAGASIN.**

### CONSEILS D'ENTRETIEN :

- 1 > DÉPOUSSIÉREZ SOIGNEUSEMENT.
- 2 > HUMECTER UN CHIFFON DOUX ET PROPRE D'EAU LÉGÈREMENT SAVONNEUSE (OU DÉTERGENT).



**- NE JAMAIS UTILISER DE PRODUITS ABRASIFS: POUDRE, LAINE D'ACIER, SOLVANTS. - NE PAS MOUILLER TROP COPIEUSEMENT.**

	PAPIER DECOR	SURFACES STRATIFIÉES	SURFACES LAQUÉES	BOIS VERNIS	TEXTILE CUIR
EAU SAVONNEUSE (SAVON NEUTRE)	○	○	○	○	○
EAU ADDITIONNÉE		○	○		
ENTRETIEN SPÉCIFIQUE FABRICANT					○

## DEUTSCH - SCHWEIZ

### MONTAGE ANLEITUNG:

- 1 > DIE MONTAGEANLEITUNG SORGFÄLTIG DURCHLESEN.
- 2 > DIE EINZELTEILE DES MÖBELSTÜCKS ERMITTELN.
- 3 > DIE BESCHLÄGE ZUSAMMENLEGEN UND PRÜFEN.
- 4 > DAS NOTWENDIGE WERKZEUG ZURECHTLEGEN.
- 5 > EINEN MONTAGEBEREICH FREIMACHEN.
- 6 > DAS MÖBELSTÜCK ZUSAMMENBAUEN.



**NIEMALS DIE VERBINDUNGEN ZU STARK ANZIEHEN. DIE SCHRAUBEN NACH EINIGER ZEIT DES GEBRAUCHS ERNEUT FESTZIEHEN. DIE MONTAGEANLEITUNG GUT AUFBEWAHREN: SOLLTE EIN TEIL FEHLEN, IST SIE DAS BESTE VERSTÄNDIGUNGSMITTEL MIT IHREM GESCHÄFT.**

### PFLEGEHINWEISE :

- 1 > SORGFÄLTIG ENTSTAUBEN.
- 2 > MIT EINEM WEICHEN, SAUBEREN UND FEUCHTEM TUCH UND LEICHTER SELFENTAUGE REINIGEN.



**- BENUTZEN SIE KEINE SCHEUERMITTEL WIE PULVER, STAHLWOLLE, LÖSUNGSMITTEL. - NICHT ZU NASS ABWLSCHEN.**

	DEKORPAPIER	OBERFLÄCHE LAMINAT	OBERFLÄCHE LACK	LACKIERTEM HOLZ	TEXTIL LEDER
SEIFENLAUGE (NEUTRALSEIFE)	○	○	○	○	○
WASSER MIT HAUSHALTSRFINIGER		○	○		
PRODUZENT SPEZIFISCHER UNTERHALT					○

## ITALIANO - SVIZZERA

### CONSIGLI DI MONTAGGIO

- 1 > STUDIARE BENE LE ISTRUZIONI DI MONTAGGIO.
- 2 > PRENDERE CONOSCENZA DEI PEZZI CHE COSTITUISCONO IL MOBILE.
- 3 > RAGGRUPPARE E CONTROLLARE LA FERRAMENTA.
- 4 > MUNIRSI DEGLI UTENSILI NECESSARI.
- 5 > PREPARARE UNA ZONA DI MONTAGGIO.
- 6 > PROCEDERE AL MONTAGGIO.



**NON FORZARE MAI GLI ASSEMBLAGGI. RESTRINGERE LE VITI DOPO UN PERIODO D'UTILIZZO. CONSERVARE QUESTE ISTRUZIONI DI MONTAGGIO, POICHE', SE UN PEZZO DOVESSE MANCARE, ESSE SAREBBERO IL MIGLIORE MEZZO DI COMUNICAZIONE CON IL RIVENDITORE**

### CONSIGLI PER LA MANUTENZIONE :

- 1 > SPOLVERATE ACCURATAMENTE.
- 2 > INUMIDIRE CON ACQUA LEGGERMENTE INSAPONATA UNO STRACCIO MORBIDO E PULITO.



**- NON UTILIZZARE MAI PRODOTTI ABRASIVI: POLVERE, LANA DI ACCIAIO, SOLVENTI. - NON BAGNARE ECCESSIVAMENTE.**

	CARTA	SUPERFICI STRATIFICATE	SUPERFICI LACCATE	SUPERFICI LACCATE / LEGNO VERNICIATO	TESSILE / CUIRO
ACQUA CON SAPONE (SAPONE NEUTRO)	○	○	○	○	○
ACQUA CON DETERSIVO		○	○		
MANUTENZIONE SPECIFICA PRODUTTORE					○

# emmezeta

## TÜRKÇE

### MONTAJ TALİMATLARI:

- 1 > Montaj tanıtım yazısını dikkatlice okuyunuz.
- 2 > Mobilyanızı oluşturan parçaları işaretleyiniz.
- 3 > Hırdavatla ilgili parçaları bir araya toplayıp; kontrol ediniz.
- 4 > Gereken araç ve gereci tedarik ediniz.
- 5 > (Kendinize) Bir montaj alanı ediniz.
- 6 > Monte etmeye başlayınız.



**MONTAJLARI ZORLAMAYINIZ.**  
**BİRKAÇ KULLANIMDAN SONRA VİDALARI SIKIŞTIRINIZ.**  
**BİR PARÇANIN KAYBOLMASI DURUMUNDA MAĞAZANIZLADAKİ**  
**KOLAY İLETİŞİME GEÇEBİLMEYİ İÇİN MONTAJ KULLANIM**  
**TALİMATINIZI SAKLAYINIZ.**

### BAKIM TALİMATLARI:

- 1 > TOZUNU DİKKATLİCE ALINIZ.
- 2 > YUMUŞAK BİR BEZİ TEMİZ SU VE AZ MİKTARDA SABUNLA(DETERJAN) NEMLENDİRİNİZ.



**- ASLA AŞINDIRICI ÜRÜNLER**  
**KULLANMAYINIZ : ÇELİK YÜNÜ,**  
**SOLVENT...**  
**- BOL SUYLA YIKAMAYINIZ.**

	SÜS KAĞIDI	KATMAN YÜZEY	LAKE YÜZEY	ÇİRALI TAHTA	TEKSTİL DERİ
SABUNLU SU (NÖTR SABUN)	○	○	○	○	○
DETERJAN KATILMIŞ SU		○	○		
ÜRETİCİYE ÖZGÜ BAKIM					○

## ENGLISH

### ASSEMBLY ADVICE :

- 1 > CAREFULLY READ THE ASSEMBLY INSTRUCTION.
- 2 > IDENTIFY THE COMPONENTS OF THE FURNITURE.
- 3 > GROUP AND CHECK THE HARDWARE.
- 4 > USE THE REQUIRED TOOLS.
- 5 > CREATE AN ASSEMBLY ZONE.
- 6 > MAKE THE ASSEMBLY.



**NEVER FORCE THE CONNECTIONS.**  
**RE-TIGHTEN THE SCREWS AFTER FEW DAYS.**  
**PLEASE RETAIN THE AI LEAFLET FOR FUTURE REFERENCE,**  
**THE AI CONTAINS INFORMATION WHEN CLAIMING**  
**FOR MISSING PARTS.**

### CLEANING ADVICE:

- 1 > CAREFULLY REMOVE THE DUST.
- 2 > USE A SOFT, CLEAN DAMP CLOTH WITH SOAPY WATER.



**NEVER USE ABRASIVE PRODUCTS**  
**OR SOLVENTS.**  
**DO NOT APPLY EXCESSIVE PRESSURE**  
**WHEN USING THE DAMP CLOTH.**

	PAPER DECOR	LAMINATED SURFACES	LACQUERED SURFACE	VARNISHED WOOD	LEATHER TEXTILE
SOAPY WATER (NEUTRAL SOAP)	○	○	○	○	○
WATER WITH DETERGENT		○	○		
SPECIFIC SUPPLIER CLEANING					○

## SRBIJA

### SAVETI ZA MONTAŽU:

1. PAŽLJIVO PROČITAJTE UPUTSTVA ZA MONTAŽU
2. PROVERITE DA LI IMATE SVE DELOVE
3. SAKUPITE I PROVERITE OKOVE ZA MONTAŽU
4. PRIPREMITE POTREBAN ALAT
5. PRIPREMITE PROSTOR ZA MONTAŽU
6. POČNITE DA MONTIRATE
7. SAČUVAJTE OVA UPUTSTVA
8. PROIZVOD JE NAMENJEN ISKLJUČIVO ZA KUĆNU UPOTREBU



**NEMOJTE UPOTREBLJAVATI SILU PRILIKOM SKLAPANJA, NAKON**  
**NEKOG VREMENA PONOVO PRITEGNITE ŠRAFOVE, ČUVAJTE**  
**UPUTSTVA ZA MONTAŽU, U SLUČAJU NEDOSTATAKA NEKOG DELA**  
**NAJBOLJE DA KONTAKTIRATE PRODAJNO MESTO.**

### UPUTSTVA ZA ODRŽAVANJE:

1. PAŽLJIVO OBRISATI PRAŠINU
2. PREBRISATI ČISTOM, MEKOM TKANINOM NAVLAŽENOM U BLAGOM RASTVORU SAPUNA ILI DETERDŽENTA



**ZABRANJENA UPOTREBA HEMIKALIJA ILI BILO KAKVIH**  
**POMOĆNIH SREDSTAVA ZA RIBANJE, JAKIH**  
**SREDSTAVA ZA ČIŠĆENJE ILI ČELIČNE ŽICE.**  
**ZABRANJENO ČIŠĆENJE SA PREVIŠE VODE/VLAGE.**

	HARTIJA	LAMINAT	LAK	DRVO	TEKSTIL/KOŽA
RASTVOR SAPUNA	○	○	○	○	○
RASTVOR DETERDŽENTA		○	○		
NAMENSKA SREDSTVA					○

**PROIZVOD JE NAMENJEN ISKLJUČIVO ZA KUĆNU UPOTREBU**

# emmezeta

## ESPAOL

### CONSEJOS PARA EL MONTAJE:

- 1 > ESTUDIE ATENTAMENTE EL MANUAL DE MONTAJE.
- 2 > LOCALICE LAS PIEZAS QUE CONSTITUYEN SU MUEBLE.
- 3 > REUNA Y CONTROLE LOS TORNILLOS.
- 4 > EQUIPE-SE DE LAS HERRAMIENTAS NECESARIAS.
- 5 > PREPARE UMA ZONA DE MONTAJE.
- 6 > REALICE EL MONTAJE.



**NO FUERCE NUNCA EN LAS UNIONES. APRIETE LOS TORNILLOS DESPUES DE CIERTO TIEMPO DE UTILIZACION CONSERVE SU MANUAL DE MONTAJE, SI FALTARA UNA PIEZA, SERIA LA MANERA MAS FACIL DE COMUNICAR CON LA TIENDA.**

### CONSEJOS PARA EL MANTENIMIENTO:

- 1 > DESPOLVOREAR CULDADOSAMENTE.
- 2 > HUMEDECER UN PANO SUAVE Y LIMPIO CON AGUA LIGERAMENTE ENJABONADA.



**- NO USE NUNCA PRODUCTOS ABRASIVOS TALES COMO: POLVO DE LIMPIAR, LANA DE ACERO, SOLVENTES. - NO MOJAR EXAGERADAMENTE.**

	PAPEL DE DECORACION	SUPERFICIE ESTRATIFICADAS	SUPERFICIE MAQUEADAS	MADERA BARNIZADA	TEXTIL CUERO
AGUA Y JABON (JABON NEUTRO)	○	○	○	○	○
AGUA COM DETERGENTE		○	○		
MANTENIMIENTO ESPECIFICO DEL FABRICANTE					○

## PORTUGUS

### CONSELHOS DE MONTAGEM:

- 1 > ESTUDE BEM AS INSTRUÇÕES DE MONTAGEM.
- 2 > REUNA AS PEÇAS QUE CONSTITUEM O SEU MÓVEL.
- 3 > REAGRUPE AS FERRAGENS.
- 4 > EQUIPE-SE COM AS FERRAMENTAS NECESSÁRIAS.
- 5 > PREPARE UMA ÁREA PARA A MONTAGEM.
- 6 > INICIE A MONTAGEM.



**NUNCA FORÇAR OS ENCAIXES. REAPERTAR OS PARAFUSOS APÓS UM TEMPO DE UTILIZAÇÃO. GUARDAR AS INSTRUÇÕES DE MONTAGEM. CASO FALTE ALGUMA PEÇA, O MAIS ACONSELHÁVEL É CONTATAR O REVENDEDOR.**

### CONSELHOS PARA A MANUTENÇÃO :

- 1 > ELIMINAR BEM O PÓ.
- 2 > UMEDECER UM PANO SUAVE E LIMPO COM ÁGUA E UM POUCO DE SABO.



**- NUNCA UTILIZAR PRODUTOS ABRASIVOS: SAPONÁCEOS, L DE AÇO, SOLVENTES. - NO MOLHAR DEMASIADO.**

	ACABAMENTO IMITAÇÃO	SUPERFÍCIES ESTRATIFICADAS	SUPERFÍCIES LACADAS	MADEIRA ENVERNIZADA	TEXTEIS PELES
ÁGUA COM SAB O (SABO NEUTRO)	○	○	○	○	○
ÁGUA COM DETERGENTE		○	○		
INSTRUÇÕES ESPECÍFICAS DO FABRICANTE					○

## HRVATSKA

### UPUTE ZA MONTAŽU:

- 1 > PAŽLJIVO PROČITAJTE UPUTE ZA MONTAŽU.
- 2 > PRIPREMITE SVE DIJELOVE NAMJEŠTAJA.
- 3 > PRIKUPITE I PROVJERITE OKOVE ZA MONTAŽU.
- 4 > PRIPREMITE POTREBAN ALAT.
- 5 > PRIPREMITE PROSTOR ZA MONTAŽU.
- 6 > POČNITE MONTIRATI.
- 7 > SAČUVAJTE OVE UPUTE.
- 8 > PROIZVOD JE NAMJENJEN ISKLJUČIVO ZA KUĆNU UPORABU.



**NEMOJTE UPOTREBLJAVATI SILU PRILIKOM SKLAPANJA NAKON NEKOG VREMENA PONOVRNO PRITEGNITE VIJKE ČUVAJTE UPUTE ZA MONTAŽU, U SLUČAJU NEDOSTATKA NEKOG DIJELA NAJBOLJE ĆE BITI DA KONTAKIRATE PRODAJNO MJESTO.**

### UPUTE ZA ODRŽAVANJE:

- 1 > PAŽLJIVO OBRISATI PRAŠINU.
- 2 > PREBRISATI ČISTOM, MEKOM TKANINOM NAVLAŽENOJ U BLAGOJ OTOPINI SAPUNA ILI DETERD ŽENTA.



**-ZABRANJENA JE UPOTREBA KEMIKALIJA ILI BILO KAKVIH POMOĆNIH SREDSTAVA ZA RIBANJE JAKIH SREDSTAVA ZA ČIŠĆENJE ILI ČELIČNE VUNE. -ZABRANJENO JE ČIŠĆENJE SA PREVIŠE VODE/VLAGE.**

	PAPIR	LAMINAT	LAK	DRVO	TEKSTIL / KOŽA
OTPINA SAPUNA	○	○	○	○	○
OTPINA DETERDŽENTA		○	○		
NAMJENSKA SREDSTVA					○

PROIZVOD JE NAMJENJEN ISKLJUČIVO ZA KUĆNU UPORABU!