

RUMBA 852

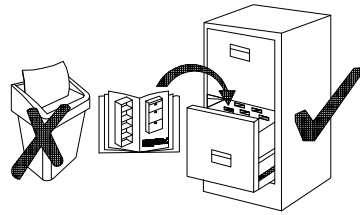

- BJ203F
- WH203F
- DL203F
- SO203F
- GRDL203F

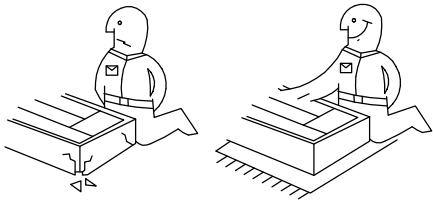
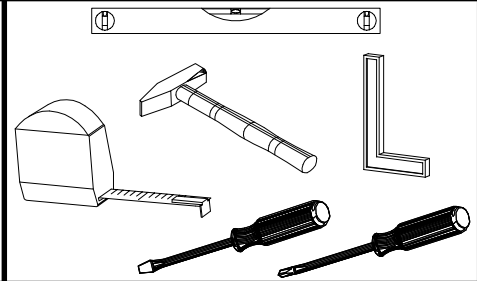
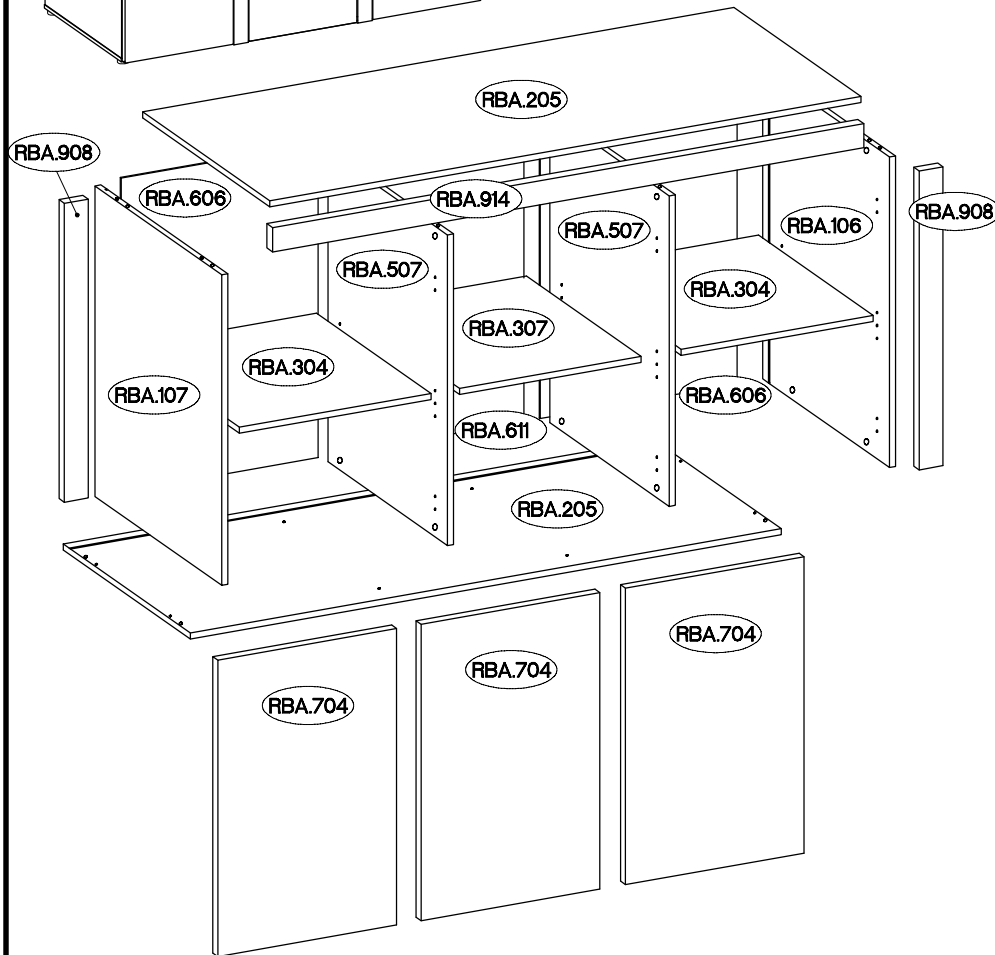
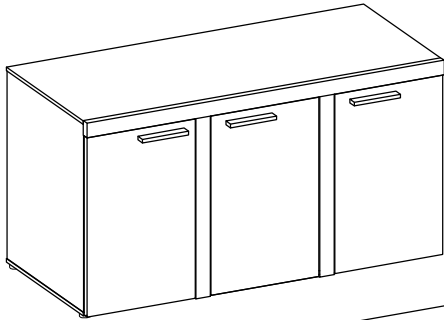

Coli	Ersatzteil Nummer	Dimension
1/2	RBA.106	770x384x15
	RBA.107	770x384x15
	RBA.307	457x347x15
	RBA.606 x2	779x496x2,5
	RBA.611	779x472x2,5
	RBA.704 x3	450x735x15
	RBA.908 x2	741x60x16
2/2	RBA.205 x2	1488x384,5x15
	RBA.304 x2	483x347x15
	RBA.507 x2	770x362x15
	RBA.914	1488x60x18

$\pm 10 \times 50 \text{mm}$	$\pm 4.0 \times 16 \text{mm}$
O7	L9
2	26
$\pm 4.0 \times 25 \text{mm}$	
P14	T9
6	9
	T4
6	2

L=128mm	$\pm 4.0 \times 30 \text{mm}$	$\pm 5/16 \text{mm}$	$\pm 3.0 \times 20 \text{mm}$			
S1	R2	J3	P7	L2	L	F10
3	6	12	10	10	10	6
$\pm 8 \times 30 \text{mm}$	L=20mm	$\pm 15/12 \text{mm}$			$\pm 35/0 \text{mm}$	$\pm 35/16 \text{mm}$
A	D2	C	E	H	G	G2
8	16	16	16	6	4	2
						$\pm 3.5 \times 13 \text{mm}$
						P5
						14

ISM-RBA-03

1

±8x30mm A	L=20mm D2	±15/12mm C	T9	T4	F10	±4.0x25mm P14	±4.0x16mm P1
8	16	16	9	2	6	6	13

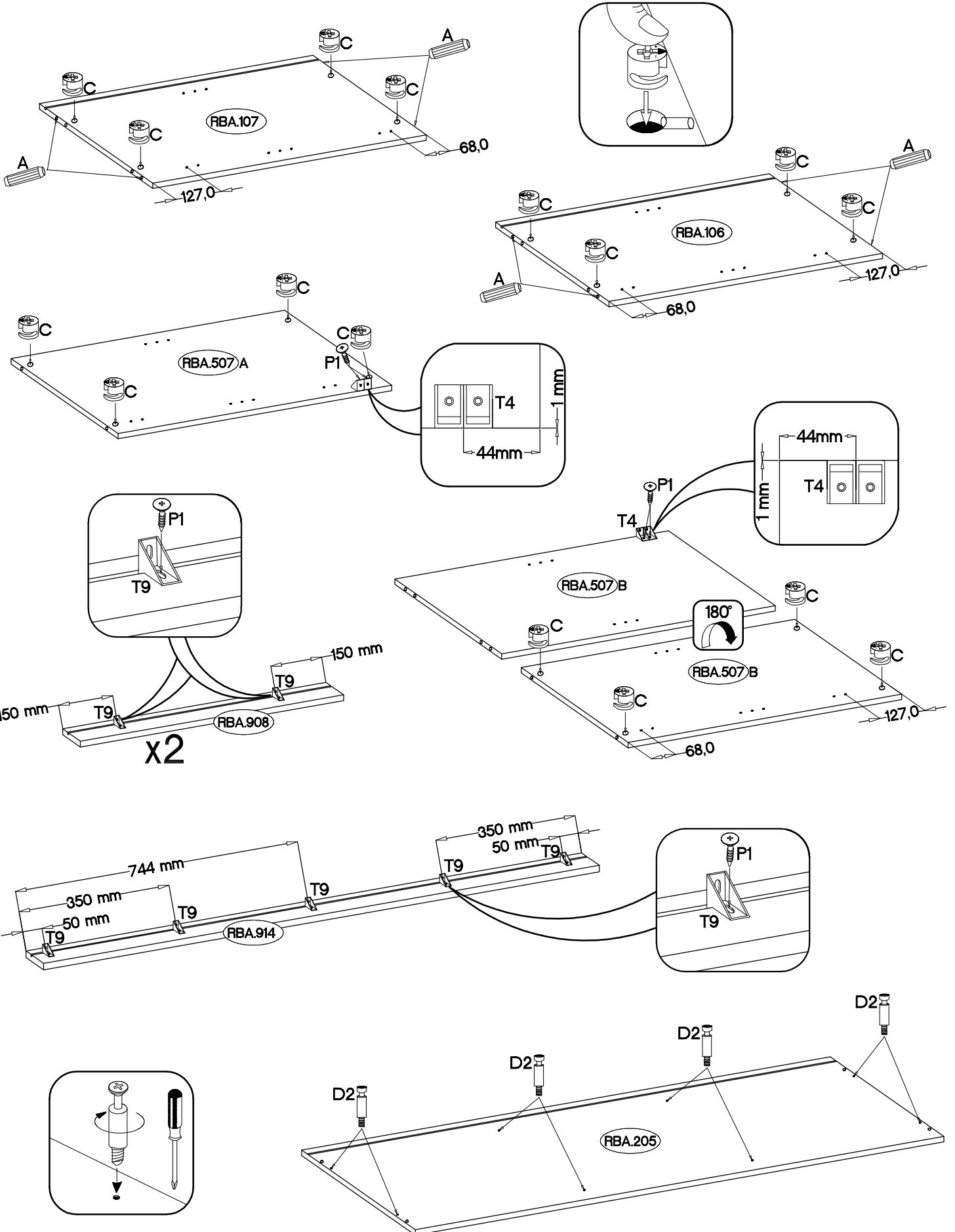

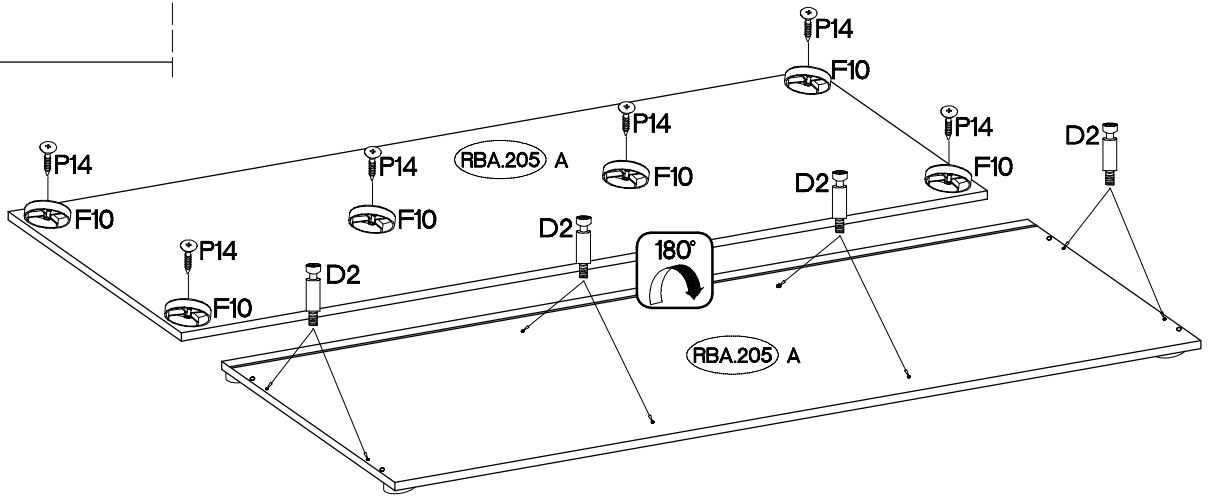
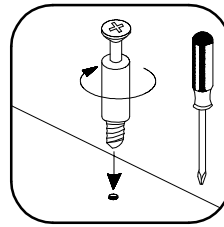
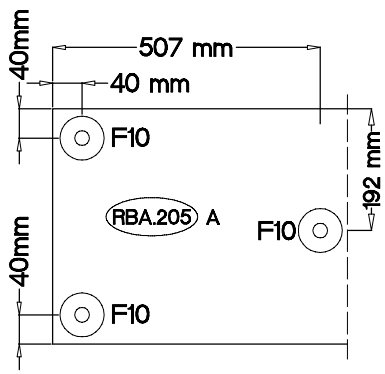

2

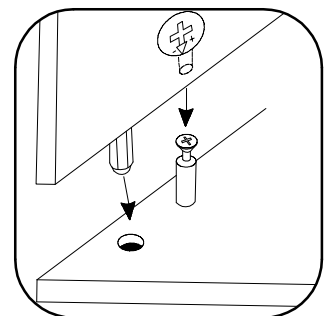
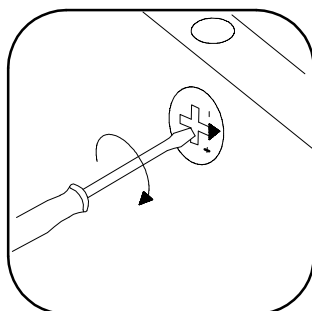
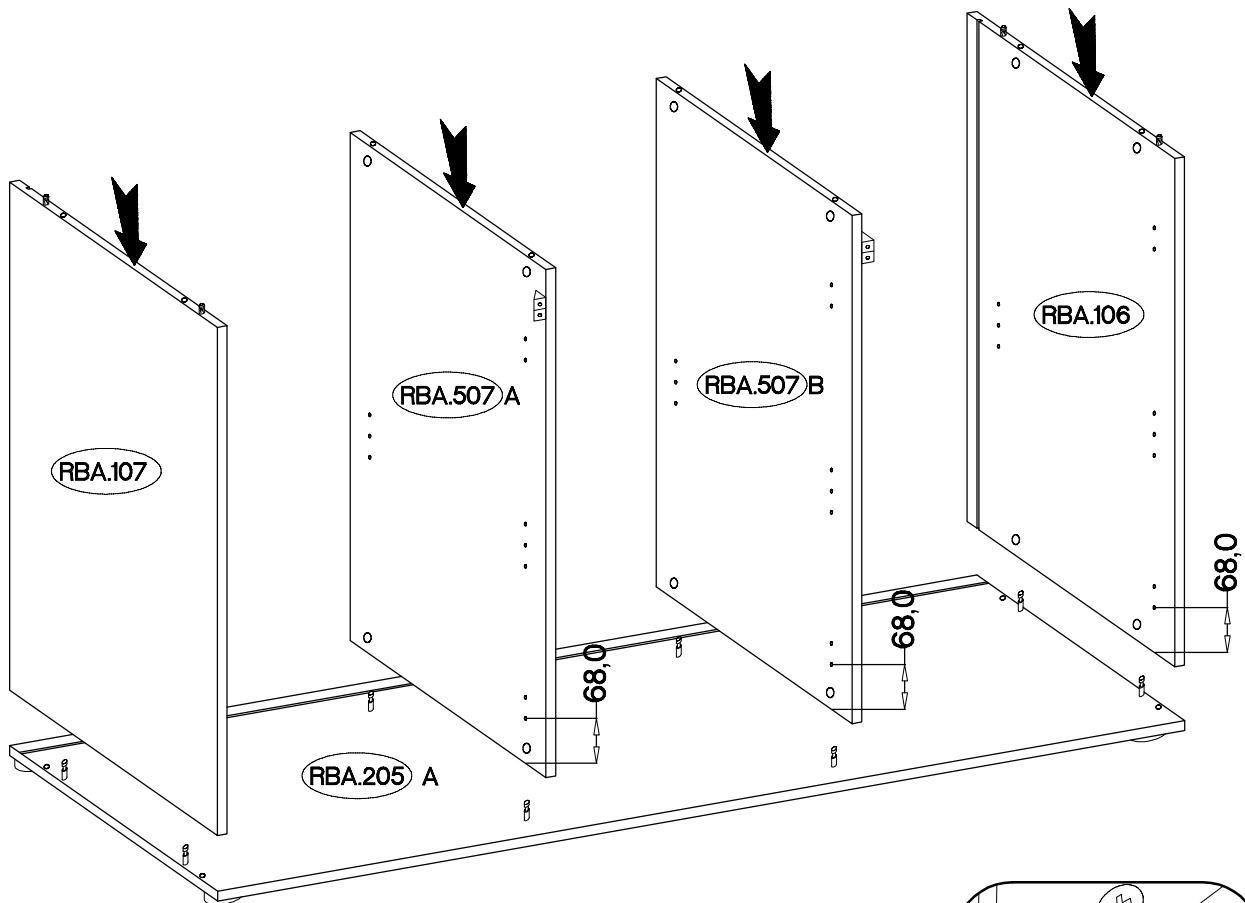

5

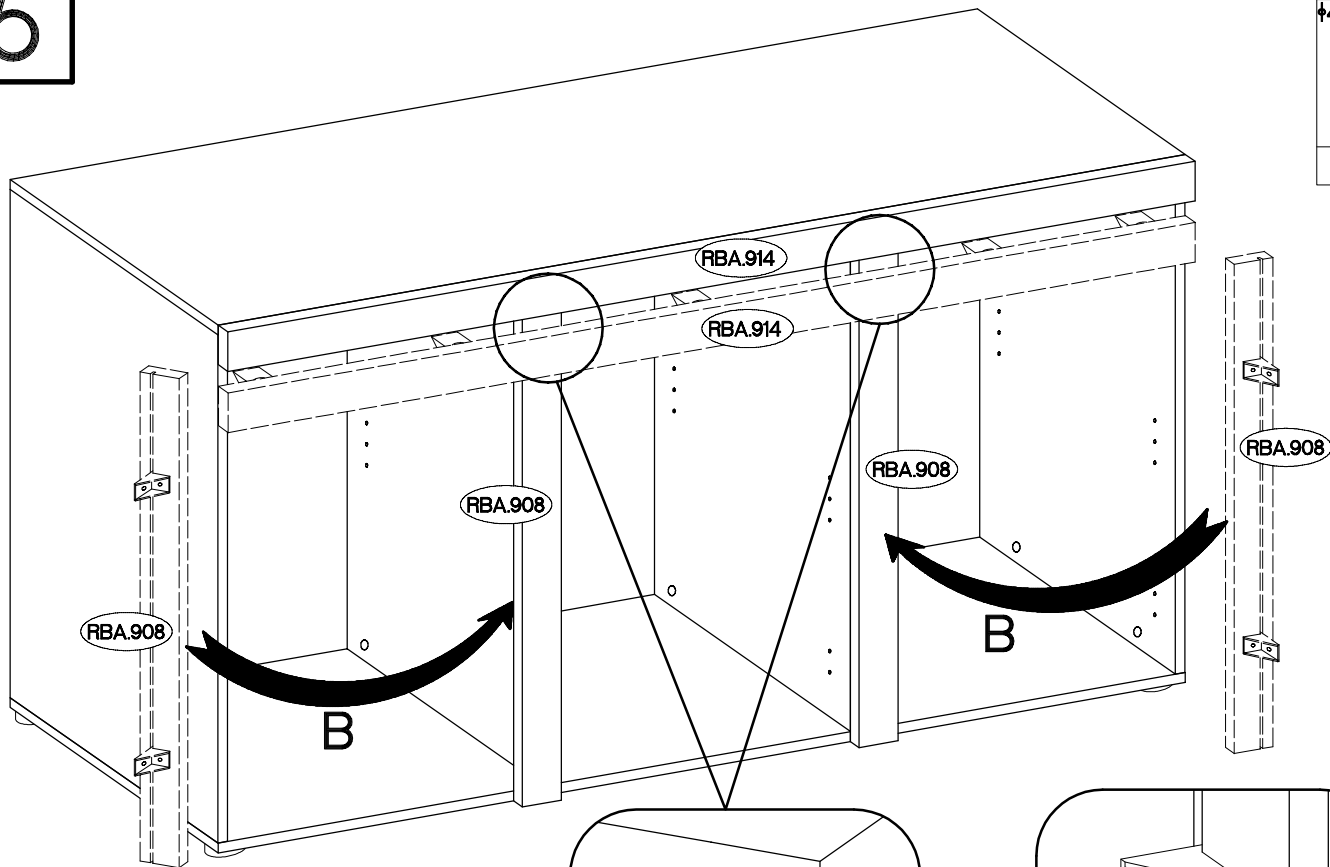

±4.0x16mm



P1

13

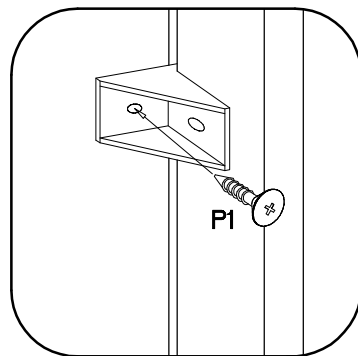
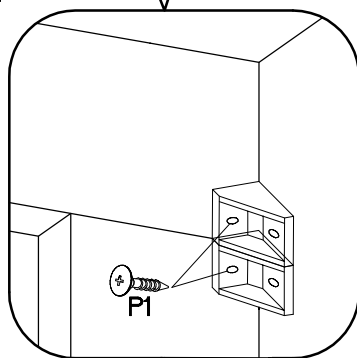

6

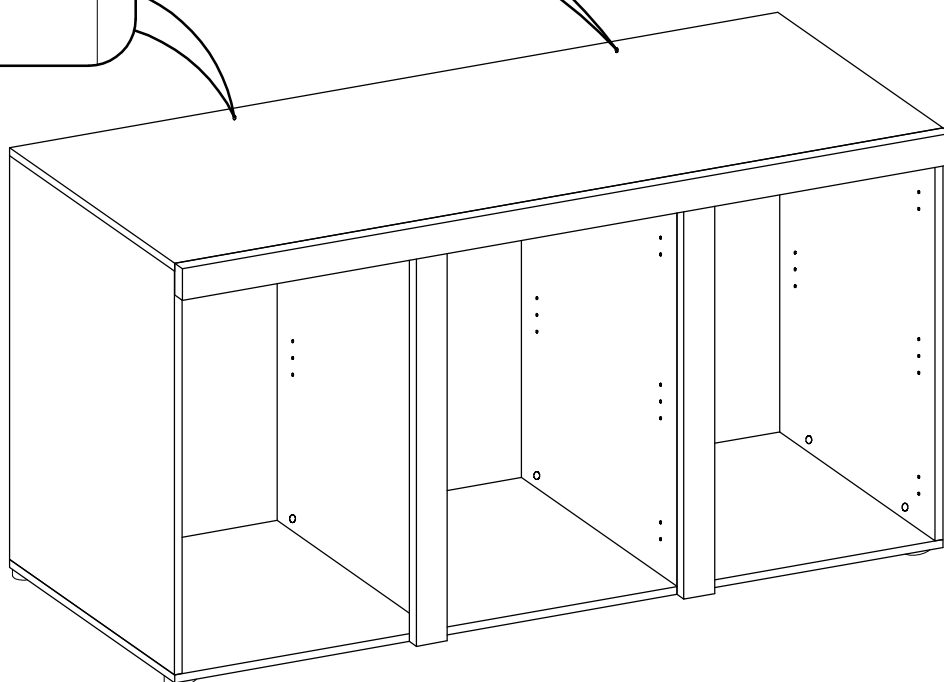
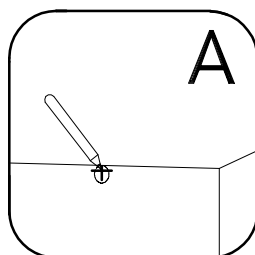

±10x50mm



O7

2

±3.5x13mm



P5

2

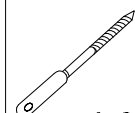

L9

2

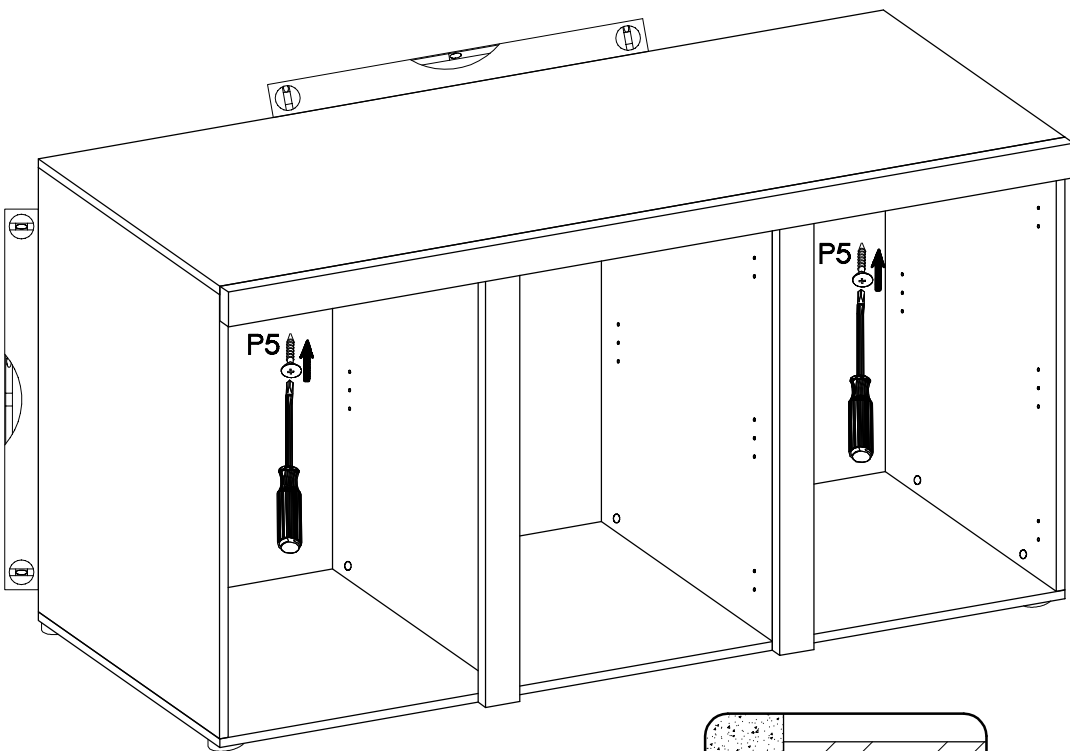
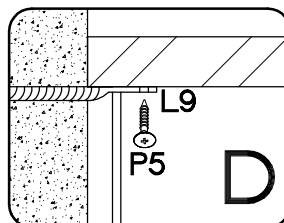
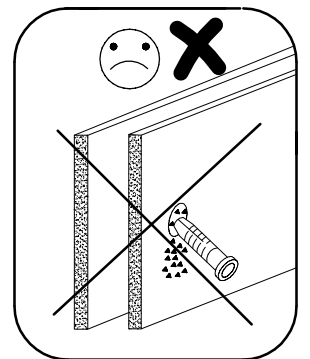
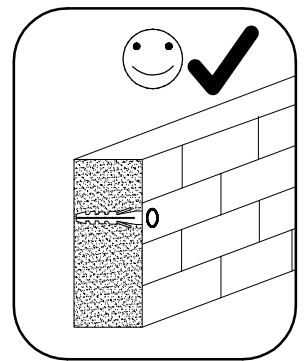
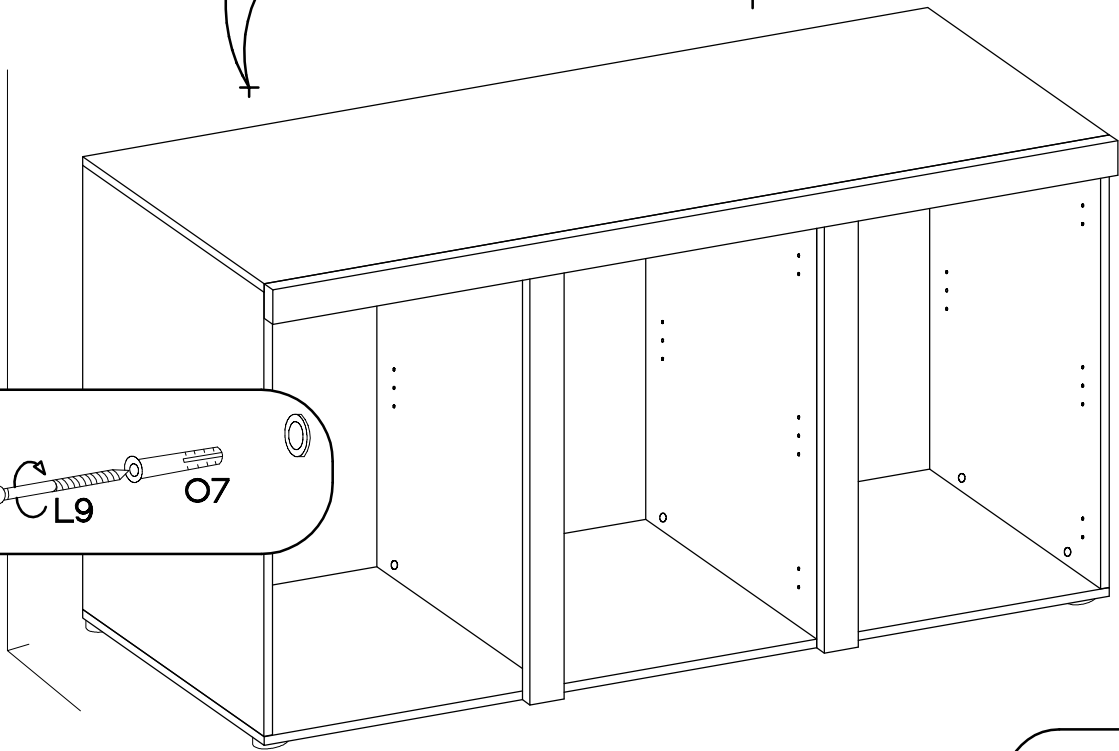
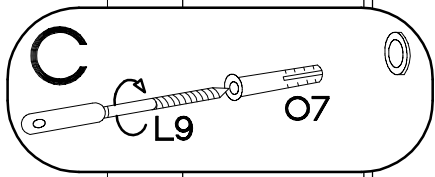
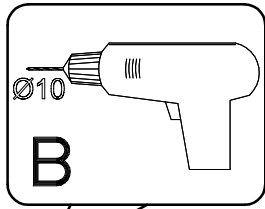

7

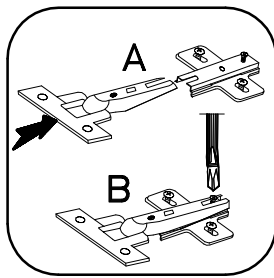

±35/16mm G2	±3.5x13mm P5
2	12
H	±35/0mm G
6	4

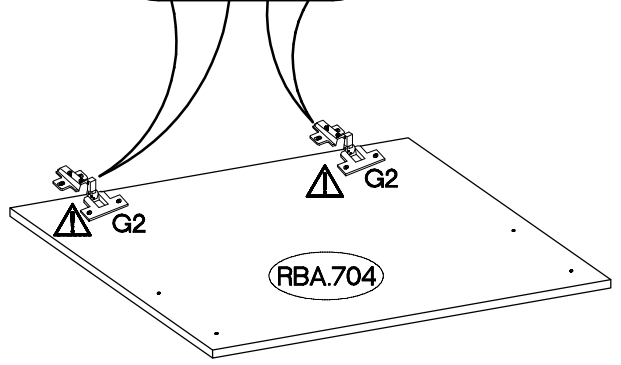
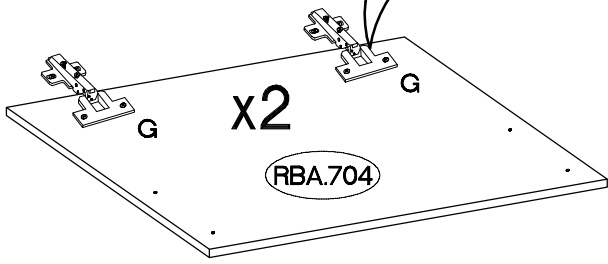
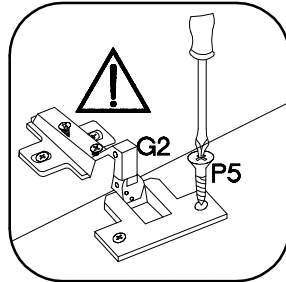
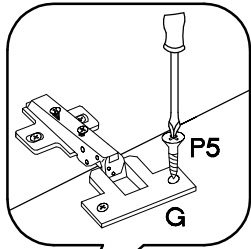

8

±5/16mm J3	E
12	16

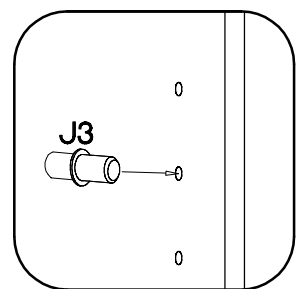
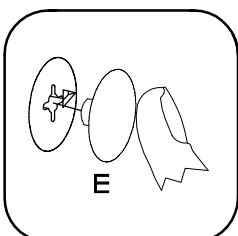
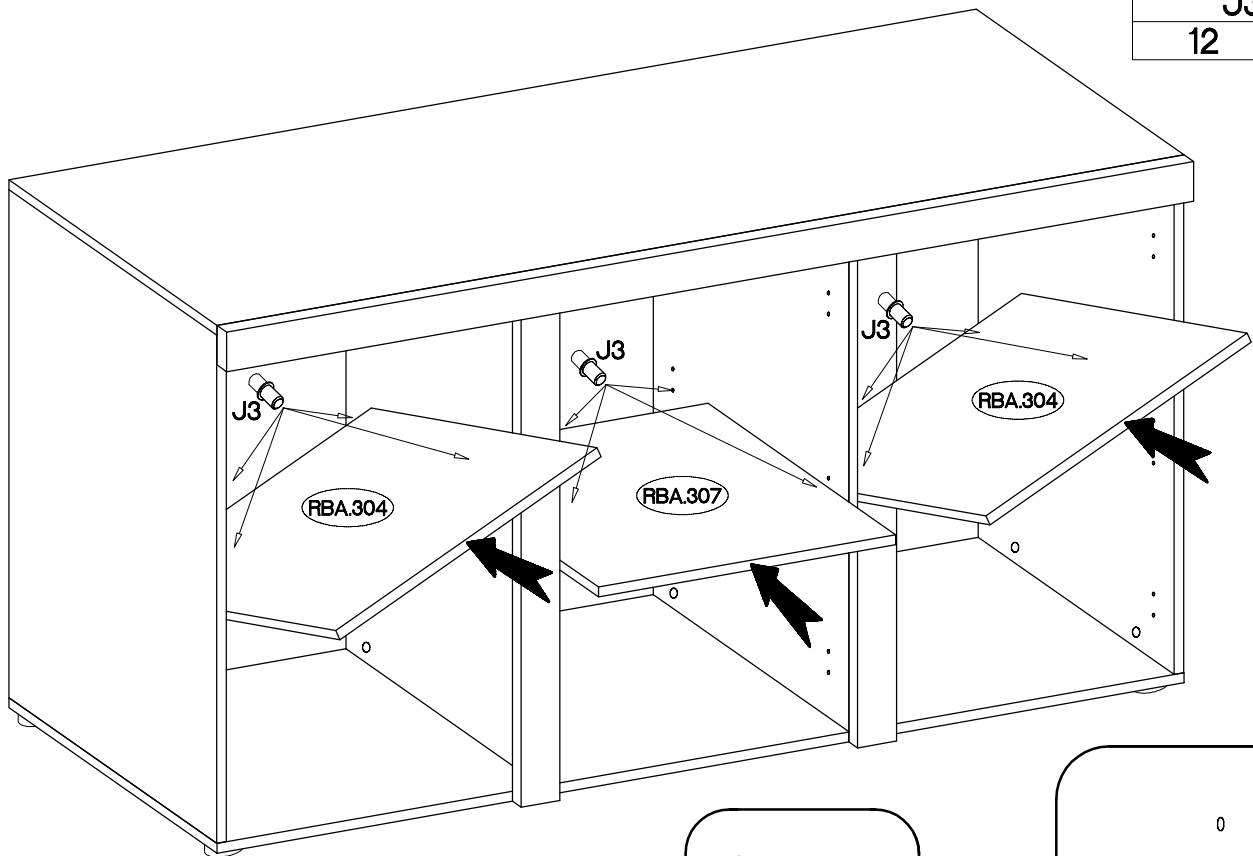

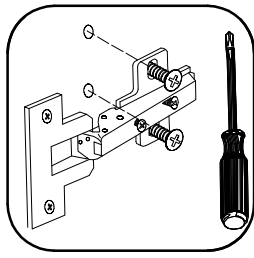

L=128mm	4.0x30mm
S1	R2
3	6

